

Double-acting pneumatic linear actuators Type SCxxx-xxx



Example illustrations, not all possible type variants are shown!

Language version: English

Original installation instructions with operating instructions and technical appendix in accordance with EU Machinery Directive (MRL) 2006/42/EC

If required, additional information can be downloaded or ordered from the following addresses:

www.ebro-armaturen.com

EBRO Armaturen International Est.+ Co.KG

Gewerbestraße 5

CH-6330 Cham

Switzerland

☎ +41 (0)41 748 5959

Fax +49 (0)41 748 5999

Contents

	Page
A) GENERAL	3
A1 EXPLANATION OF SYMBOLS	3
A2 INTENDED USE	3
A3 DIVERGENT USE	4
A4 IDENTIFICATION OF THE ACTUATOR	4
A5 TRANSPORT AND STORAGE	5
B) ASSEMBLY OF THE ACTUATOR ONTO THE VALVE AND CONNECTION OF ADDITIONAL MODULES	6
B1 SAFETY INSTRUCTIONS DURING ASSEMBLY	6
B2 CONDITIONS FOR THE COMBINATION OF VALVE AND PNEUMATIC CYLINDER	6
B3 INTERFACES	7
B4 COMPRESSED AIR CONNECTIONS	7
B5 ASSEMBLY ONTO A VALVE	8
B6 <i>ADJUSTING THE CYLINDER STROKE LENGTH</i>	10
B7 <i>INSTALLING THE VALVE/CYLINDER UNIT IN THE PIPE SECTION</i>	10
B8 <i>SUPPORT OF THE CYLINDER</i>	10
B9 <i>CHECKLIST FOLLOWING INSTALLATION OF THE VALVE/CYLINDER UNIT IN THE PIPE SECTION</i>	11
B10 TEST RUN FOR ALL ACTUATORS: TEST STEPS TO COMPLETE ASSEMBLY AND CONNECTION	11
B11 ADDITIONAL INFORMATION: DISASSEMBLING THE ACTUATOR	12
C) OPERATION AND MAINTENANCE	13
C1 SAFETY INSTRUCTIONS FOR OPERATION	13
C2 AUTOMATIC OPERATION / MANUAL OPERATION	13
C3 OPERATION	14
C4 MAINTENANCE	14
C5 TROUBLESHOOTING	14
C6 SUPPLEMENT TO THE OPERATING INSTRUCTIONS FOR THE ATEX AREA	15
D) TECHNICAL APPENDIX/PLANNING DOCUMENTS	16
D1 DURABILITY	16
D2 CORROSION PROTECTION	16
D3 TECHNICAL CHARACTERISTICS OF THE ACTUATOR	16
D4 NOTES ON RISKS ARISING FROM CONTINUOUS OPERATION	16
D5 NOTES ON OTHER RISKS	16
DECLARATION OF INCORPORATION OF PARTLY COMPLETED MACHINERY	17



A) General

In this instruction a “Pneumatic cylinder for knife gate valves” is denominated shortly “cylinder” or “SC” and the knife gate valve simply “valve”.

The instruction of a valve to which this cylinder is installed on, applies with priority. Instructions for the accessories, if any, should be observed.

A1 *Explanation of symbols*

In this operating instruction, notes are marked with the following symbols:

 Xxxxxxx	Danger/Warning ... indicates a situation of immediate danger that could result in death or severe injury if not avoided.
	Note ... indicates an instruction that should be respected.
	Information ... indicates Information useful to follow

A2 *Intended use*

Pneumatic linear actuators of type SCxxx-xxx are intended to be used,

- After connection of the accessory for compressed air supply and exhaust (i.e. solenoid valve or other device),
- with compressed air in accordance with the type plate of the SC actuator,
- under ambient conditions between -20°C and +80°C (standard), or between -40°C and +120°C (special designs)
- to actuate valves (primarily valves) with a specific stroke with the electrical signals of the above mentioned controls in the positions <OPEN>, <CLOSED> or intermediate positions. There are also manual solenoid valves to be used to open/close the actuator without any signals.

The actuating force and characteristics of the actuator must be adjusted to the valve - see technical appendix/catalogue pages.

The compressed air must have a dew point of -20°C (or at least 10°C below the ambient temperature) (in compliance with ISO 8573-1, Class 3). The compressed air must be lightly oiled for switching cycles >4x/min.

	Solenoid valves usually require a filter with a mesh size of 40 µm (ISO 8573-1, Class 5).
---	--

The actuator may only be operated in accordance with the following documents:

- the <Manufacturer's declaration on SC Directives> included in the delivery
- this instruction **BA6.4 – MRL** (also included in the delivery).
- The safety instructions in sections B1 and C1 must be observed when installing and operating the actuator.

	<p>The connection diagram to be used depends on the intended use of the valve: this must be decided and selected accordingly by the purchaser/customer of the actuator. For connection diagrams for typical applications, see section B4.</p>
---	---

Note 1:

These instructions should be used in conjunction with the instructions for the valve to which the actuator is assembled on. The valve instruction applies with priority.

Note 2:

The customer is responsible for allocation of an individually supplied actuator to the appropriate valve.

A3 Divergent use

In agreement with the manufacturer, EBRO-Armaturen International, the actuator can be used with media other than compressed air.

A4 Identification of the actuator

Every actuator is identified by a type plate as follows:

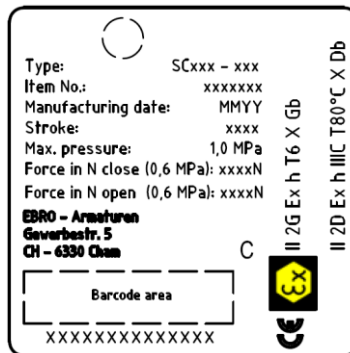



SCxxx-xxx



The label on the actuator shall not be covered after assembly of the actuator on the valve and after installation in the pipe section – this to ensure the actuator remains identifiable.

 Danger	<p>Exceeding the maximum pressure indicated on the label can lead to malfunction</p>
--	--

A5 Transport and storage

	<p>If an actuator is already <u>assembled on the valve</u>: The transport and storage requirements in the instructions for the valve applies with priority. In all cases, the unit is to be stored at constant temperature in an enclosed area within the temperature limits for valve and actuator.</p>
 Danger	<p>For the correct transport <u>of individually supplied actuators</u>, the following applies:</p> <ul style="list-style-type: none"> • Always observe the symbols on the packaging when transporting the packages. • Until the actuator is assembled onto a valve, keep it in the factory packaging. • Place the actuator on its flat side; any mounted accessories (e.g. solenoid valve/limit switches or manual override) must be positioned to the side or on top. • Protect the actuator from dirt and moisture. • If required, only use securing straps (not chains) as a transport aid in connection with eyelets at the screw points on the top of the actuator. • Special caution to the air pipe on SC250-SC320. It is not allowed to lift the actuator with straps on the cylinder.

The following is **additionally** to be observed for storage:



- All air connections and electrical plug-in contacts must be covered.
- Flanges and unprotected components must be protected with suitable grease or oil.

	<p>When fitting a strap, ensure that it is not fastened to any additional modules. Protect the actuator from any damage during transport.</p>
---	---



B) Assembly of the actuator onto the valve and connection of additional modules

	<p>These instructions include safety instructions for foreseeable risks during assembly of the cylinder onto a valve.</p> <p>It is the user's responsibility to complement these instructions for other risks, especially those arising from the system and surrounding environment.</p>
---	---

B1 Safety instructions during assembly

	<ul style="list-style-type: none"> • Any assembly and disassembly work is to be completed by qualified personnel only. Qualified personnel are persons who, on the basis of their training, specialist knowledge and professional experience, can correctly assess and execute the work assigned to them and can identify and avoid potential risks. • The actuator must only be used as described in section A2 <Intended use>. • The same requirements for the compressed air supply system and the local plant control system are to be complied with for the cylinder. These requirements must be additionally complied with when connecting the cylinder. • No exterior loads must be applied to the cylinder. If it needs to be supported, section B6 need to be observed. • The cylinder and accessories must be protected from such ambient influences that can pose a functional risk. • Make sure that access to the installation site, as well as the installation site itself, is easily accessible and provides sufficient space, lightning, visibility for installation. After assembling the actuator should be freely accessible.
 Danger	<ol style="list-style-type: none"> 1. Assembly of a cylinder onto a valve is only permitted if the valve has been disassembled from the pipe system or completely depressurised and the pipe section is empty. 2. A valve with actuator may only be operated once all gate guards have been properly attached. <p>If these warnings are not observed, life and health of the personnel are at risk.</p> <p>Any other procedure is the user's responsibility.</p>
 Danger	<p>During installation, the actuator must be secured against falling at all times. To do this make sure that exclusively validated and approved hoists are used. The assembly may only be completed by qualified personnel.</p> <p>Avoid a physical overload.</p>

B2 Conditions for the combination of valve and pneumatic cylinder

	<p>The interface of valve/cylinder must have identical dimensions. In order to ensure this, the purchaser must supply all required information with the order (type and DN of the valve etc.).</p>
	<p>For reasons of safety, a valve with pneumatic actuator may only be operated <u>once all gate guards have been properly assembled on the valve.</u></p> <p>If this is not observed, life and health of the personnel are at risk.</p> <p>These gate guards partly prevent the visual check of the valve's gate position. If required, two electronic limit switches can be installed onto the valve for indicating of opened and closed position. .</p>
 Warning	<p>For beams with holes for limit switches, the black protective caps must not be removed from the holes.</p>

OPERATING INSTRUCTIONS FOR PNEUMATIC LINEAR ACTUATORS SCXXX-XXX

The connection of any additional electric/electro-pneumatic modules supplied with the actuator is described in the accompanying documentation and must be observed.

These documents apply in addition to these instructions.





Installation of accessories not intended for this purpose is not permitted.

Permitted are for example sensors for stop position monitoring and position controllers.

B3 Interfaces

The customer must ensure the compatibility of the following interfaces:

- Actuator/valve connection
- The valve manufacturer must have specified the suitable dimensions and tolerances on the actuator piston.
- If accessories (e.g. solenoid valve, sensors) are not supplied by the manufacturer, the customer must ensure the functional/interface compatibility with actuator and accessories.

	The interface of valve/cylinder must have identical dimensions. In order to ensure this, the purchaser must supply all required information with the order (type and DN of the gate valve etc.).
	Safety instructions of accessories must be followed.
	For reasons of safety, a knife gate valve with actuator may only be operated <u>once all protective plates have been properly attached</u> . If this is not observed, life and limb of the personnel are at risk. These protective plates prevent the visual check of the valve plate's position – for this reason, if required, two electronic limit switches must be installed in the assembly openings of the protective plates provided for this purpose.
 Warning	For protective plates without limit switches, the black protective caps must not be removed from the drilled holes.

B4 Compressed air connections

The compressed air connections of the pneumatic cylinder have an interface according to <Namur VDI/VDE 3845> and threaded holes according to ISO 228-1:

Cylinder size	Connection	Compressed air supply *)
SC100	G ¼"	6 mm
SC125	G ¼"	8 mm
SC160	G ¼"	10 mm
SC200	G ½"	12 mm
SC250	G ½"	15 mm
SC320	G ½"	18 mm



*) This inner dimension must be larger in case of long air feed lines

Suitable seals are to be used for the screw connections in the cylinder.

The pipework for the compressed air supply to the cylinder should be at least the same size as the air connections

If the feed line is undersized, this can result in a malfunction.

	Suitable seals are to be used for the screw connections in the cylinder. Use only dedicated tools.
---	---

	Silencer for exhausting air shall be used to minimize noise emission.
	The access, as well as the visibility of the connections must be ensured. Avoid a physical overload.

	For the compressed air supply, the requirements of the accessory manufacturer (if available) are also to be observed.
---	---

B5 Assembly onto a valve

- When assembling the cylinder, **the valve must not be installed in the pipe section** so that the stroke of the valve plate can be closely monitored during assembly and properly adjusted.
- **Before assembly of the cylinder onto the valve**, the following must be ensured:
 - The cylinder \emptyset and the stroke of the piston rod must be accurately adjusted to the valve type;
 - The valve/cylinder interface must be at a right angle to the valve stem and precisely centred to it;
 - The quality of the compressed air corresponds to the specifications in section A2 <Intended use> and the compressed air connections comply with the specifications in the table in section.
- **When assembling** the cylinder, the following is to be prepared (pos. number see Fig. 3):
 - The clevis pin (20) and the split pins(21) match,
 - The two -gate guards cover the stroke of the gate,
 - The beams of the valve have drilled holes for assembling and disassembling the coupling between the valve stem and the piston rod,
 - The compressed air meets the requirements for operating the installed cylinder,

Assembly of a cylinder with adjustable gate clevis onto the valve

Assemble in the following steps:

1. Make sure that the valve is closed.
2. Position the lock nut (28) and the gate clevis (17) in the centre of the thread on the piston rod.
3. Place the cylinder on the interface on the valve and align the beams on the top of the valve with the intermediate flange of the cylinder respectively.
4. Tighten the four nuts on the interface manually.
5. Connect the air supply and move the piston rod (25) toward the gate (8) by gently operating the cylinder. Make sure that the hole in the gate clevis (17) will interface with the hole in the gate and with the hole in the beam in order to attach the clevis pin (20). Make sure that the cylinder, the attachment profiles on the top of the valve and the valve gate are in exact alignment
6. Then connect the clevis (17) with the gate (6) using the clevis pin (20) and secure it with the split pins (21). Tighten the cylinder at the interface to the beams with the four nuts Fasten evenly and crosswise while holding the beams together
7. Leave the gate in the position, depending on valve type;

BV	partially open (1/3)
D2G	closed
HG	open or closed
HP	open or closed
HX	open or closed
JTV	open or closed
MV	partially open (1/3)
RKO	open or closed
SLF	open
SLH	open
SLV	open
SLX	open
TV	partially open (1/3)
WB	partially open (1/3)
XV	closed

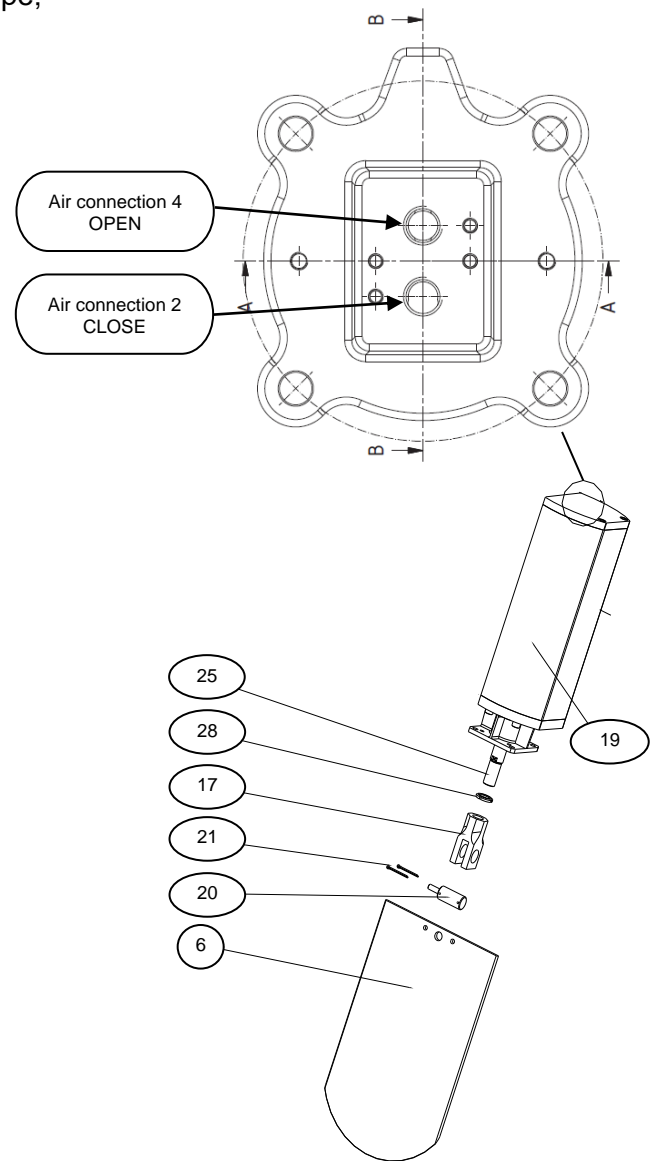

Fig. 3
Cylinder with adjustable coupling

B6 Adjusting the cylinder stroke length

Ensure that the cylinder is properly assembled.

All cylinder types:

1. Open the gate by gently operating the cylinder. The piston rod (25) must be in its top position in the cylinder. In this position, the gate should not have left the valve bore completely.
2. Measure the distance Y (see Figure 4) between the edges of the retainer ring in the valve body and the lowest part of the gate.
3. If $Y \neq 0$ mm, slowly close the valve .
If $Y = 0$ mm, go to step 6.

Setting the cylinder stroke length

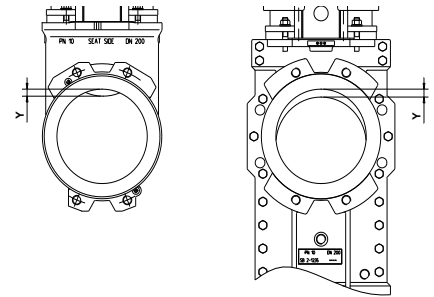

Loosen the split pins (21) and pull out the clevis pin (20) to disconnect the gate clevis(17) from the gate(6). Open the cylinder far enough to adjust the gate clevis (17) in the thread.

Then raise the gate clevis (17) by the dimension “Y” (see Fig. 4) on the piston rod (25) and secure with the locking nut (28).

4. With pressure in the cylinder, slowly move the gate clevis (17) back over the gate (6) again until the drilled holes are in exact alignment, then attach the clevis pin (20) and split pins (21) again. Slowly close the gate 100% at first, then move back to the completely open position and check the overhang “Y” – see figure
5. Following this adjustment, the bottom edge of the gate should no longer extend into the opening of the valve in the open position – if it does, the procedure in steps 2 to 4 must be repeated, as otherwise the gate would be too low in the seat in the closed position.
If the gate extends into the opening in the open position, this could throttle the flow and/or cause erosion at the bottom edge of the gate.
6. Finally, the gate guards must be securely screwed to the valve – see warning in section B2.
7. Unscrew the compressed air supply, then go to step 9.
8. *If electronic end switches are provided:*
Press out the black protective caps, disassemble the gate guards and install the associated electronic limit switches – observe the related manufacturer's instructions in doing so.



If no limit switches are provided, the black protective caps must remain in the beams to protect the operating personnel from injury!

B7 Installing the valve/cylinder unit in the pipe section



For the valve installation follow the instructions given in the Original valve installation and service instructions.

Connect the cylinder and accessories, if any, to the air supply and control system. For correct air connection see A6. Follow the relevant accessory instruction, if any.

B8 Support of the cylinder

Normally the cylinder does not need any support (or will it be needed in any case considering only the pneumatic cylinder?), but valve/cylinder units that are exposed to vibrations or other mechanical stresses can be subject to deformations and must therefore be supported. Contact your local office for advice.

B9 Checklist following installation of the valve/cylinder unit in the pipe section

The following tests must be performed before commissioning a valve/actuator unit:

1. Is the air pressure sufficient?

At least the same air pressure must be available at the cylinder air connections. The pressure must remain within the limit that is shown on the type plate of the actuator.

2. Is the feed line for the compressed air adequately dimensioned?

The compressed air supply for the cylinder must be adequately dimensioned.

Note:

Jerk-free functioning of the valve plate usually confirms that this is the case.

3. Is the stroke of the valve plate correctly adjusted?

Depending on the control signal, the valve must reach both OPEN and CLOSED positions precisely. How to readjust the stroke is described in section B6.

4. Is the solenoid valve correctly connected?

- Depending on the control signal, the valve must reach both OPEN and CLOSED positions precisely
- If control pressure is present **but the control signal fails** (to check: pull the plug!), the actuator must operate the valve as follows:



Cylinder type	Correct action
Double-acting	<i>If not specified differently in the order:</i> The valve must move to the “CLOSED” position

5. Actuator/valve connection correctly tightened?

	A valve with an actuator must never be operated without gate guards. These must be attached securely and permanently.
---	--

B10 Test run for all actuators: test steps to complete assembly and connection

For this section, see comment above which also are applicable on this section.

 Danger	A valve must only be operated with a pneumatic actuator if both protective plates are properly and permanently attached so that the stroke of the valve plate is completely enclosed. See comments on this earlier. If these warnings are not observed, life and limb of the personnel are at risk.
 Gefahr	All screw connections must realised as described in chapter B. The connection between the valve and the actuator must comply with EN ISO 5211 and the screw connections must be secured with the specified torques.

To ensure flawless operation of the actuator during automated operation, the following tests must be performed **on each actuator/valve unit** after assembly:

• Is the control pressure sufficient at the point of use?

The control pressure directly at the solenoid valve should be at least that shown on the actuator type plate, ensuring smooth operation of a valve under operating conditions.

• Is the solenoid valve correctly connected?

If control pressure is present but the control signal fails (to test: e.g. pull out the plug), the valve must move into the position specified by the purchaser/customer, normally, it will close unless otherwise stated / ordered

If this is not the case, the drive control and/or connection of the solenoid valve must be corrected accordingly. Remedy: see troubleshooting section.



- Actuator/valve connection correctly tightened?
In functional testing, no relative movement between the valve, mounting adapter and pneumatic actuator should be detectable. If necessary, re-tighten all screws and nuts on the adapter, see table Pneumatic connection.
- Testing actuation function and display:
When control pressure is applied, the control commands “**CLOSED**” and “**OPEN**” must cause the valve to **move into the corresponding** end positions.
- Check electrical position feedback (if module present):
The electrical signals “**OPEN**” and “**CLOSED**” (in the plant controlled system-side control centre) must be compared with the actual position of the valve. **Signal and position must match.** If this is not the case, the control and/or the adjustment of the sensors must be checked. The component manufacturer’s installation instructions must also be complied with.

B11 Additional information: disassembling the actuator

The same safety rules are to be observed as for the piping system, the compressed air supply and the (electrical/electro-pneumatic) control system. The valve instruction must be followed first.

The following applies to all cylinders:

1. The pipe section of the valve must be depressurised and empty of media.

	If the entire valve/cylinder unit is to be removed from the line, the assembly and operating instructions for <u>the valve</u> must be observed.
	As long as an actuator is disassembled, no pressure must be applied to the valve.

2. Move the gate to the fully closed position so that the clevis pin (20) can be pulled out through the lower of the two holes in the attachment profiles of the valve.
A limit switch, if any, must be removed first.
3. Ventilate the valve and interrupt the compressed air supply to the cylinder.
4. Disconnect all electrical connections.
5. Remove the split pin(21) from the clevis pin (20) and pull the out of the gate clevis (17).
6. Remove the 4 screws/nuts from the interface of the cylinder/gate and lift the cylinder off the valve. If required, use straps for transport – see section A5.
Make sure that no accessory gets damaged during removal.
7. Refer to section A5 for storage of disassembled cylinder.



C) Operation and maintenance

In accordance with MD 2006/42/EC (Machine directive), manufacturers must perform a comprehensive risk analysis. EBRO-Armaturen provides the following documents for this purpose:

- This installation and operating instructions.
- Declaration of incorporation of partly completed machinery acc. to Machine Directive

	<p><i>These instructions include safety instructions for foreseeable risks arising when using the actuator in industrial applications.</i></p> <p>It is the user's responsibility to complement these instructions for other risks, especially those arising with specific valves.</p>
---	---

C1 Safety instructions for operation

	<ul style="list-style-type: none"> • The function of the cylinder must comply with the <Intended use>, which is described in section A2. • The conditions of use must comply with the specifications shown on the valve's type plate – see section A. • Any work during operation and maintenance is to be completed by qualified personnel only. For the purposes of these instructions, qualified personnel are persons who, on the basis of their training, specialist knowledge and professional experience, can correctly assess and execute the work assigned to them and can identify and avoid potential risks. • Wearing parts must only be replaced if: <ul style="list-style-type: none"> – the valve in the pipe section is depressurised and empty, – and the compressed air supply is switched off. • During each re-commissioning, it must be ensured visually that the compressed air supply and the control system are OK. • Operation is allowed only in specified temperature range. It is necessary to ensure that the temperature range will not be exceeded due to the influence e.g. of ambient or medium temperature.
 Danger	<p>A valve must only be operated with a pneumatic actuator if both protective plates are properly and permanently attached so that the stroke of the valve plate is completely enclosed. See comments on this earlier.</p> <p>If these warnings are not observed, life and limb of the personnel are at risk.</p>

C2 Automatic operation / manual operation

If the actuator is correctly assembled as described in section B, it works automatically and is designed for continuous operation.

	<ul style="list-style-type: none"> • When pneumatically powered, the actuator requires a continuous supply of compressed air to ensure stable operation.
---	---

C3 Operation

Note:

For a cylinder that is mounted on a valve, additional information can also be included in the operating instructions for the valve.

Commissioning can occur when the cylinder has passed all tests.

The cylinder must be operated by means of the signals from the system-side controller (there are other possibilities). The cylinder should be regularly checked visually for tightness or damage to ensure that the external conditions do not pose a risk for the operating personnel, the cylinder, valve and accessories.

A function test is to be performed once a month to ensure that the valve/cylinder unit functions properly.

C4 Maintenance

As long as the valve/pneumatic cylinder unit functions properly, only regular visual checks on the cylinder are required.

Wear of the cylinder depends on the quality of the compressed air used, the actuation frequency and the ambient conditions.

C5 Troubleshooting

Note 1:

For a cylinder that is mounted on a valve, additional measures can also be included in the operating instructions for this valve.

Note 2:

Wearing parts can be determined by means of the specifications on the cylinder type plate and the EBRO document <sp-EC>, see section A3

Problem	Cause	Countermeasure
Leakage on the piston rod	Worn-out rod sealing	See note in section C3 <Maintenance>
Leakage in the cylinder cover	Insufficient seal between cylinder tube and cylinder end cups	See note in section C3 <Maintenance>
The gate does not fully open/close	Insufficient air supply to cylinder Wrongly adjusted cylinder stroke Error in the actuator shut-off (= signal from the installed limit switches) Gate blocked due to deposits Damaged seat/gate Piston seal damaged	See note in section A6 <Connection> See note in section B4 <Setting> See note in section B7 <Checklist> See instructions for the valve See instructions for the valve See note in section C3 <Maintenance>
The gate opens/closes jerkily	Insufficient air supply to cylinder Gate blocked due to deposits Damaged seat/gate Piston seal damaged	See note in section B7 <Checklist> See instructions for the valve See instructions for the valve See note in section C3 <Maintenance>

The manufacturer EBRO Armaturen or Stafsjö Valve offer maintenance and repair services.

Please also contact EBRO Armaturen or Stafsjö Valves or the closest manufacturer representative for additional information.

C6 Supplement to the operating instructions for the ATEX area

General:

The ATEX symbol  identifies devices for use in potentially explosive atmospheres (ATEX, Directive 2014/34/EU).

The operating and maintenance instructions BA 6.4, as well as the supplementary document BA 6.4 – ATEX, are to be observed.

The permissible operating limits (temperature, operating pressure, materials, etc.) are to be complied with.

The specifications and category can be found in the declaration of incorporation of partly completed machinery.

Trained personnel are to be used for assembly as well as maintenance tasks for the EX area.

Labelling of the devices can be found on the label



II 2G Ex h T6 X Gb
II 2D Ex h IIIC T80°C X Db



Installation:

Installation must be carried out by trained personnel and in compliance with BA 6.4, as well as the supplementary document BA 6.4 – ATEX.

The supplementary document BA 6.4 – ATEX/MRL is available from the manufacturer and can be found on the Homepage at www.ebro-armaturen.com.

Impermissible use of the device is the responsibility of the operator.

Equipotential bonding between all metallic conducting materials must be observed.

Operation:

The permissible operating limits must be observed. Usage is the responsibility of the operator.

Contaminations like dust and dirt deposits are to be avoided.

Maintenance and repair:

Maintenance work is to be performed by qualified, trained personnel.

Only original spare parts must be used.

The operator is responsible for maintenance and repair tasks.

It is important to use suitable materials and tools.

D) Technical appendix/planning documents

D1 Durability

In accordance with standard N 15714-3, Table 1 is the requirement for type testing of the actuator in endurance testing at 60% of nominal power under laboratory conditions.

The operating conditions will determine if and when the actuator requires servicing, especially the pressure and purity of the compressed air:



As a rule, the maintenance interval of an actuator is significantly longer than the maintenance interval of the valve:

► If maintenance occurs for the valve, fault-free functioning of the actuator should be checked and ensured as a minimum.

D2 Corrosion protection

All actuators correspond to corrosion category C4, acc. to ISO 12944.

D3 Technical characteristics of the actuator

Drive forces and actuation times for all types can be found in the technical datasheet (catalogue pages), available at www.ebro-armaturen.com

D4 Notes on risks arising from continuous operation

- The actuator is designed for continuous operation, in accordance with EN15714-3, Table 1.
- The actuator is screwed to the valve at the interface specification.
Actuators with higher actuation frequencies should be visually inspected at suitable intervals (no later than when the valve is serviced) to check that this screw fastening remains tight – it should be tightened if required.
- The actuator is designed for operation with clean or slightly oiled dry compressed air in accordance with section 1 <Intended use>.

D5 Notes on other risks

- *Mechanical loads:*
 - Actuators are not “stepladders”: external loads must be kept away from the valve, actuator and accessories.
 - The actuator is designed for static loading within the piping system. Risks arising from loading caused by vibrations in the system are not covered: in such cases, the long-term securing of the screw fastenings on the actuator must be agreed with the manufacturer, EBRO-Armaturen, as a minimum.

Declaration of incorporation of partly completed machinery

The manufacturer

EBRO Armaturen International Est. Co. KG
Gewerbstraße 5
CH-6330 Cham
Switzerland

declares that pneumatic linear actuators
Typ SCxxx-xxx

are manufactured in accordance with the requirements of the following standards:

DIN EN ISO 5211:2017-08	Industrial valve part-turn actuator attachment
VDI/VDE 3845 :2010-09	Interfaces of valves and auxiliary equipment
DIN EN 12100:1997-11	Safety of machinery
ISO 8573-1:2010-04	
Cl. 3 and 5	Compressed air – contaminants and purity classes

The following product documents are available:

Technical documentation, BA-6.4_SC-MRL

These products conform to the following directives:

Machinery Directive 2006/42 EG (MRL) [applies if the valve is actuated otherwise than by hand.]

1. The products are an “incomplete machine” in the sense of article 2 g) of this directive
2. The table overleaf lists whether and how the requirements of this directive are fulfilled
3. This declaration is the mounting declaration in the sense of this directive

For conformity with the above- named directives, the following apply:

1. The user must comply with the <correct use> as defined in the “Original mounting and operating instructions” (BA-6.4_SC-MRL) included in the delivery and must follow all notices in these instructions. Failure to comply with these instructions can – in serious cases – release the manufacturer from product liability.
2. Commissioning of this partly completed machinery is not permitted until conformity of the system in which the valve is installed with all the above- mentioned EC directives is declared by the person responsible. A specific declaration is included in delivery for the above - named actuator.
3. The manufacturer, EBRO ARMATUREN, has carried out and documented the required risk analyses. The employee responsible for making this documentation available is Mr. Matthias Jortzik of EBRO ARMATUREN.

Cham, April 2018

CEO

OPERATING INSTRUCTIONS FOR PNEUMATIC LINEAR ACTUATORS SCXXX-XXX

The manufacturer	EBRO ARMATUREN Gebr. Bröer GmbH, D58135 Hagen
declares that the EBRO pneumatic actuators SCxxx-xxx meet the following requirements:	
Requirements according to Annex I Machinery Directive 2006/42/EC	
1.1.1., g) Intended use	See operating instructions
1.1.2., c) Incorrect use warnings	See operating instructions
1.1.2., c) Required protective equipment	Exactly as for the pipe section in which the valve is installed
1.1.2., e) Accessories	No special tool is required for changing wearing parts
1.1.3 Components in contact with media	The materials for the parts in contact with media are determined before delivery and are specified both in the type data sheet and the EBRO order confirmation. The user is required to carry out an appropriate risk analysis for resistance to the operating medium.
1.1.5 Handling	Fulfilled by the notices in the installation instructions
1.2 and 6.2.11 Control	The responsibility of the user and in accordance with the installation instructions for the actuator
1.3.2 Prevention of breakage risks	For functional parts: guaranteed through the intended use of the actuator
1.3.4 Sharp corners and edges	Requirement fulfilled
1.3.7/8 Risk of injury by moving parts	Requirement fulfilled if used as intended. Maintenance and repair only permissible with actuator deactivated and power supply switched off
1.5.1 – 1.5.3 Power supply	The responsibility of the user. See also installation instructions for the actuator
1.5.5. Operating temperature	Warning notice against unacceptable temperatures: see operating instructions, section <Intended use>
1.5.7 Explosion	 protection required. Must be expressly agreed in the purchase order. In this case: use only as marked on the actuator.
1.5.13 Emission of hazardous substances	Not applicable
1.6.1 Servicing	See operating instructions. Holding of spare part stock to be agreed with EBRO Armaturen International Est. + Co.KG.
1.7.3 Marking	Valve: in accordance with assembly instructions. Actuator: see documentation from manufacturer of the actuator.
1.7.4 Operating instructions	These assembly instructions also contain instructions for the use of the actuator. Additional information required for the operation of the <complete machine> is the responsibility of the planner/user.
Annex III	The actuator is not <complete machinery>: therefore it has no CE marking for conformity with the Machinery Directive
Annexes IV, VIII-XI	Not applicable
in compliance with EN 12100	
1. Applicability	The basis for this is decades of experience in the use of the types of actuators named on page 1. <i>Note: It is essential that the user carries out a risk analysis of the pipe section and the valves installed therein that is specially adapted to the operating conditions in accordance with sections 4 to 6 of EN 12100 – such an analysis is not possible for the manufacturer, EBRO Armaturen International Est. + Co.KG. in respect of standard valves.</i>
3.20, 6.1 Inherently safe design	The actuators are manufactured according to <inherently safe design> principles
Analysis according to sections 4, 5 and 6	Experience of faulty operation and misuse documented by the manufacturer in the context of cases of damage (documentation in accordance with ISO9001) was used as the basis.
5.3 Limits of the machine	Limiting of the <incomplete machinery> was carried out in accordance with the <Intended use> of the actuator.
5.4 Decommissioning, disposal	Not within the responsibility of the manufacturer, EBRO Armaturen International Est. + Co.KG.
6.2.2 Geometric factors	Since the valve and actuator comprise the functional parts when used as intended, this section does not apply.
6.3 Technical protective devices	Where applicable, only required for accessories – see order confirmation.
6.4.5 Operating instructions	Since valves with actuators work automatically based on the command signals from the controller, the operating instructions describe those aspects that are <typical of the actuator> and must be provided to the manufacturer of the (pipeline) system
Risk analysis	The risk analysis was carried out in accordance with DIN EN ISO 12100:2011 and is recorded in document RB SC – EN12100.