

Global Product Range

Variable Area Flow Meters

Type 335, Short Version, Special Version



Variable Area Flow Meters

Reliable, accurate and economical

Variable area flow meters from GF Piping Systems are radially installed dismantable meters for flow measuring in industrial piping applications. The measurement ranges, which are attuned to our customers' needs, and the range of materials available for the tubes and connection ends, mean that the flow meters can be used for a wide range of applications and a great variety of media.

Main advantages

- The flowmeters require no auxiliary power
- Cost effective to measure the flow rate
- Break-proof and corrosion-resistant
- Accessories like sensor 4-20 mA and limit contacts
- Guiding rod from DN50 for stabilisation of float within volume flow
- Low pressure loss
- Can be used for liquids and gases
- Volume- and % scale as standard

Measuring principle

Three main forces act on the float

- The weight G
- The buoyancy A
- The flow force K

$$G = A + K$$

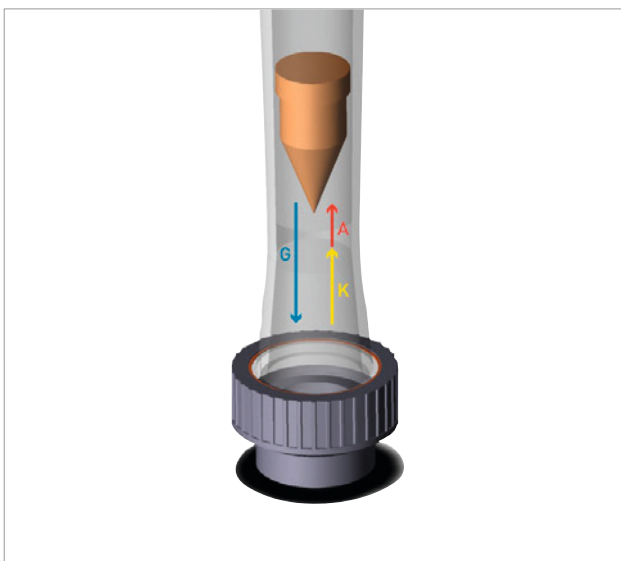

Segments

- Water Treatment
- Chemical Process Industry
- Microelectronics
- Food & Beverage
- Ship Building
- Building technology
- And many more



Know your flow

All the flow meters are equipped with a double scale: a percentage scale as well as a scale for the flow volume in l/h for water (H₂O). Special scales are on offer for m³/h, GPM, in addition to special graduations for HCL, NaOH, air and can be affixed on taper tubes without scales subsequently. Measuring accuracy is based on VDI/VDE 3513, Part 2 - 2008 with an error limit of G = 5%, and a linearity limit of q_G = 50%.

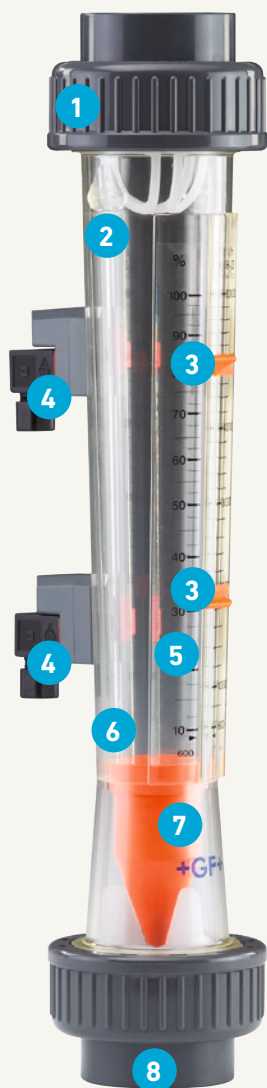

Product features

- 1 Install and remove radially with threaded joint
- 2 Wide dovetail guide for easy fastening of limit switches
- 3 Flow immediately visible with setpoint indicators
- 4 One limit switch each for min. / max. flow (optional)
- 5 Imprinted double scale for water in percent (%) and flow volume (l/h)
- 6 Transparent taper tube in a variety of materials
- 7 Orange-colored PVDF float makes it easy to read the flow
- 8 Fast connection with standardized cement socket

The float measuring principle

Accurate flow measurement of liquids and gases.

If a medium flows upwards at a sufficient rate of flow through the vertically mounted taper tube, the float is raised to the point at which a state of equilibrium sets in between the lifting force of the medium and the weight of the float. Since the mean rate of flow is proportional to the quantity flowing through per unit of time, this state of equilibrium corresponds to the measurement of the instantaneous flow rate.

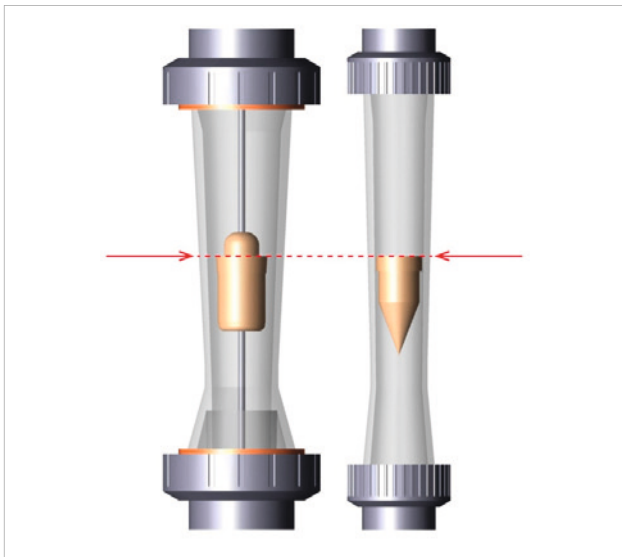

Accurate reading

The top edge of the float indicates the flow volume. If special scales are applied subsequently, it must be ascertained that the scale marking ►◄ is affixed congruently with the one on the taper tube.

Installation lengths and materials

The variable area flow meters are now available in the installation lengths 335 mm, 200 mm, 185 mm and 165 mm (on request 350mm). The taper tubes are available in Polyamid, Polysulfon and transparent PVC-U. The standard floats are in PVDF with or without magnet. The end stops are in PVDF. The threaded joint including insert is available in PVC-U, as well as in PP, PE or ABS on request. The O-rings are made of EPDM or FPM. The nominal pressure is 10 bar at 20°C. (The maximum permitted pressure for gases is 0.5 bar).



Before installing

1. The pincer-like transport lock must be removed. To do this, the upper union nut is unscrewed and the upper insert including seals is removed. Double-check the taper tube and if available the guiding rod on damages caused due to shipping.
2. Then the VAFM must be reassembled.
3. The piping system into which the VAFM is installed must be in a vertical position to ensure its functionality.
4. An inlet and outlet section must be provided for (inlet ca. 10 x DN, outlet ca. 5 x DN).

Accessories

Due to the integrated dovetail shaft it is possible to mount further accessories like 4-20 mA flow sensor GK15 or limit contacts GK10/11.

The most important data

The VDE/VDI 3513 Part 2 guideline describes the procedure for converting the scales of variable area flow meters. It takes into account all material and flow parameters including pressure, temperature, density and viscosity. GF Piping Systems offer you tables to accommodate changed operating conditions. You can find the tables in the GF Piping Systems Planning Fundamentals.

Accuracy of measurement VDI/VDE 3513, error limit G = 5%, linearity limit qG = 50%, related to the measured value

Flow rate in %	10	20	30	40	50	60	70	80	90	100
Total measurement error % of measured value	13.0	8.0	6.3	5.5	5.0	5.0	5.0	5.0	5.0	5.0
Total measurement error % of full scale value	1.3	1.6	1.9	2.2	2.5	3.0	3.5	4.0	4.5	5.0

Temperature range

Taper tube	Union	max. temperature at 1 bar
PVC-U	PVC-U	0 – 60°C
PA	PVC-U	0 – 60°C
PSU	PVC-U	0 – 60°C
PSU	PVDF	0 – 90°C
PVDF	PVDF	0 – 100°C

Pressure loss for type 335

Measuring range [l/h]	50 - 500	100 - 1000	150 - 1500	250 - 2500	200 - 2000	300 - 3000
Pressure loss [mbar]	22.84	22.84	22.84	22.84	24.99	24.99
Measuring range [l/h]	600 - 6000	1000 - 10000	1500 - 15000	2000 - 20000	3000 - 30000	8000 - 60000
Pressure loss [mbar]	24.99	24.99	28.23	45.67	45.67	47.24

Chemical resistance list

		Concentration	PA	PSU	PVC-U	
Acids	Phosphoric acid	H ₃ PO ₄	diluted / concentrated	o / -	+ / +	+ / +
	Nitric acid	HNO ₃	diluted / concentrated	- / -	o / -	o / -
	Sulfuric acid	H ₂ SO ₄	diluted / concentrated	- / -	o / -	+ / o
	Hydrofluoric acid	HF	diluted / concentrated	- / -	o / -	+ / -
	Hydrochloric acid	HCl	diluted / concentrated	- / -	o / o	o / -
	Formic acid	HCOOH	diluted / concentrated	- / -	o / o	+ / -
	Acetic acid	CH ₃ COOH	diluted / concentrated	- / -	o / o	+ / -
Bases	Ammonium hydroxide	NH ₄ OH	all	+	+	+
	Caustic potash	KOH	diluted / concentrated	+ / o	+ / +	+ / +
	Caustic soda	NaOH	diluted / concentrated	+ / o	+ / +	+ / +
Inorganics	Ferric chloride	FeCl ₃	all	+	+	+
	Sodium hypochlorite	NaOCl	diluted / concentrated	o / -	+ / -	o / -
	Sodium bisulfite	NaHSO ₃	all	+	+	+
	Hydrogen peroxide	H ₂ O ₂	diluted / concentrated	- / -	+ / -	o / -
	Brine (non-oxidative)		all	+	+	+
Organics	Glycol		diluted / concentrated	- / -	+ / +	+ / o
	Ethanol / Methanol	C ₂ H ₅ OH / CH ₃ OH	diluted / concentrated	- / -	+ / +	+ / o
	Aliphatic hydrocarbons		all	+	+	o
	Acetone	C ₃ H ₆ O	diluted / concentrated	- / -	o / -	o / -
	Formaldehyde	H ₂ CO	<= 40 %	-	+	+

X: recommended O: with limitations -: not recommended

The ratings refer to the chemical resistance of the materials and consider known cases of developing haziness with time. Due to limited experience haziness may occur in additional individual cases. No reference cases exist for media causing haziness with PA and PSU. Haziness is not regarded as chemical incompatibility.

Please note: The above list is only intended as a guideline and does not replace an in-depth review of material suitability for the particular application. The information is based on our experience and is state of the art. This data consists only of general indicators. In practice, however, other factors, for example, concentration, pressure, and jointing technology, must also be taken into consideration. The technical data is not binding and does not constitute expressly warranted characteristics of the goods. If you need further information, contact gss@georgfischer.com or visit our website and use our online tool ChemRes PLUS; it provides you with the most important basic information.

<https://www.gfps.com/chemical-resistance>

Variable Area Flow Meters

Global Product Range



Variable Area Flow Meter Type 335

Variable area flow meter type 335
Float in PVDF without magnet
With solvent cement sockets PVC-U metric



Model:

- Standard guiding rod PVDF with stainless steel core (V4A) for DN50 and DN65

Option:

- 4-20 mA sensor
- Limit contacts
- Special scales for different media
- Union nuts and connecting parts in other materials on request

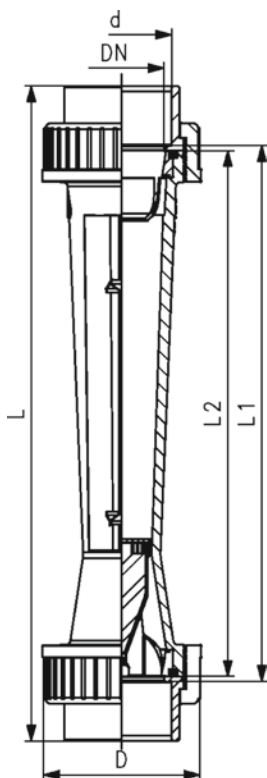

Scale range (l/h)	d (mm)	DN (mm)	Taper tube in PVC-U transp. O- rings in EPDM Code	Weight (kg)	Taper tube in Polyamid O-rings in EPDM Code	Weight (kg)	Taper tube in Polysulfone O-rings in EPDM Code	Weight (kg)
50 - 500	32	25	199 335 000	0.564	199 335 020	0.522	199 335 040	0.464
100 - 1000	32	25	199 335 001	0.473	199 335 021	0.423	199 335 041	0.528
150 - 1500	40	32	199 335 002	0.626	199 335 022	0.567	199 335 042	0.698
250 - 2500	40	32	199 335 003	0.706	199 335 023	0.620	199 335 043	0.561
200 - 2000	50	40	199 335 004	0.972	199 335 024	0.885	199 335 044	1.057
300 - 3000	50	40	199 335 005	0.952	199 335 025	0.874	199 335 045	1.038
600 - 6000	50	40	199 335 006	1.019	199 335 026	0.840	199 335 046	0.991
600 - 6000	63	50	199 335 007	1.357	199 335 027	1.381	199 335 047	1.307
1000 - 10000	63	50	199 335 008	1.299	199 335 028	1.196	199 335 048	1.252
1500 - 15000	63	50	199 335 009	1.301	199 335 029	1.355	199 335 049	1.302
2000 - 20000	75	65	199 335 010	2.513	199 335 030	2.536	199 335 050	2.639
3000 - 30000	75	65	199 335 011	2.442	199 335 031	2.286	199 335 051	2.572
8000 - 60000	75	65	199 335 012	2.293	199 335 032	2.333	199 335 052	2.432

Scale range (l/h)	D (mm)	L (mm)	L1 (mm)	L2 (mm)	G (inch)
50 - 500	58	385	341	335	1 ½
100 - 1000	58	385	341	335	1 ½
150 - 1500	72	393	341	335	2
250 - 2500	72	393	341	335	2
200 - 2000	83	403	341	335	2 ¼
300 - 3000	83	403	341	335	2 ¼
600 - 6000	83	403	341	335	2 ¼
600 - 6000	101	417	341	335	2 ¾
1000 - 10000	101	417	341	335	2 ¾
1500 - 15000	101	417	341	335	2 ¾
2000 - 20000	135	429	341	335	3 ½
3000 - 30000	135	429	341	335	3 ½
8000 - 60000	135	429	341	335	3 ½

Variable area flow meter type 335
Float in PVDF with magnet
With solvent cement sockets PVC-U metric



Model:

- Standard guiding rod PVDF with stainless steel core (V4A) for DN50 and DN65

Option:

- 4-20 mA sensor
- Limit contacts
- Special scales for different media
- Union nuts and connecting parts in other materials on request

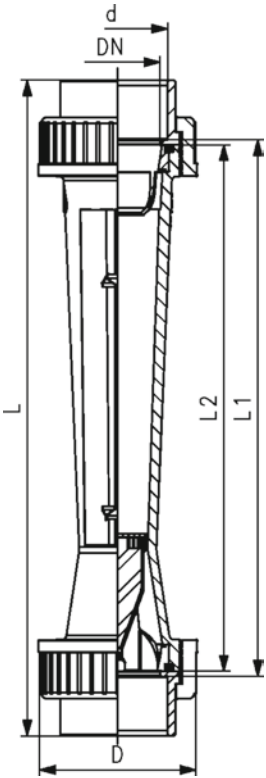

Scale range (L/h)	d (mm)	DN (mm)	Taper tube in PVC-U transp. O- rings in EPDM Code	Weight (kg)	Taper tube in Polyamid O-rings in EPDM Code	Weight (kg)	Taper tube in Polysulfone O-rings in EPDM Code	Weight (kg)
50 - 500	32	25	199 335 100	0.469	199 335 120	0.434	199 335 140	0.466
100 - 1000	32	25	199 335 101	0.547	199 335 121	0.423	199 335 141	0.452
150 - 1500	40	32	199 335 102	0.630	199 335 122	0.568	199 335 142	0.604
250 - 2500	40	32	199 335 103	0.714	199 335 123	0.547	199 335 143	0.585
200 - 2000	50	40	199 335 104	0.973	199 335 124	0.887	199 335 144	0.944
300 - 3000	50	40	199 335 105	0.952	199 335 125	0.874	199 335 145	1.035
600 - 6000	50	40	199 335 106	1.024	199 335 126	0.836	199 335 146	0.881
600 - 6000	63	50	199 335 107	1.342	199 335 127	1.240	199 335 147	1.360
1000 - 10000	63	50	199 335 108	1.303	199 335 128	1.190	199 335 148	1.248
1500 - 15000	63	50	199 335 109	1.297	199 335 129	1.351	199 335 149	1.409
2000 - 20000	75	65	199 335 110	2.508	199 335 130	2.378	199 335 150	2.441
3000 - 30000	75	65	199 335 111	2.477	199 335 131	2.472	199 335 151	2.377
8000 - 60000	75	65	199 335 112	2.294	199 335 132	2.150	199 335 152	2.150

Scale range (L/h)	D (mm)	L (mm)	L1 (mm)	L2 (mm)	G (inch)
50 - 500	58	385	341	335	1 ½
100 - 1000	58	385	341	335	1 ½
150 - 1500	72	393	341	335	2
250 - 2500	72	393	341	335	2
200 - 2000	83	403	341	335	2 ¼
300 - 3000	83	403	341	335	2 ¼
600 - 6000	83	403	341	335	2 ¼
600 - 6000	101	417	341	335	2 ¾
1000 - 10000	101	417	341	335	2 ¾
1500 - 15000	101	417	341	335	2 ¾
2000 - 20000	135	429	341	335	3 ½
3000 - 30000	135	429	341	335	3 ½
8000 - 60000	135	429	341	335	3 ½



Variable area flow meters
Float in PVDF without magnet
With solvent cement sockets PVC-U BS Inch

Model:

- Standard guiding rod PVDF with stainless steel core (V4A) for DN50 and DN65 see accessories for variable area flow meters

Scale range (l/h)	d (inch)	DN (mm)	Taper tube in PVC-U transp. O- rings in EPDM Code	Taper tube in Polyamid O-rings in EPDM Code	Taper tube in Polysulfone O-rings in EPDM Code	Weight (kg)
50 - 500	1	25	199 335 400	199 335 420	199 335 440	0.440
100 - 1000	1	25	199 335 401	199 335 421	199 335 441	0.440
150 - 1500	1 ¼	32	199 335 402	199 335 422	199 335 442	0.620
250 - 2500	1 ¼	32	199 335 403	199 335 423	199 335 443	0.620
200 - 2000	1 ½	40	199 335 404	199 335 424	199 335 444	0.900
300 - 3000	1 ½	40	199 335 405	199 335 425	199 335 445	0.900
600 - 6000	1 ½	40	199 335 406	199 335 426	199 335 446	0.900
600 - 6000	2	50	199 335 407	199 335 427	199 335 447	1.225
1000 - 10000	2	50	199 335 408	199 335 428	199 335 448	1.225
1500 - 15000	2	50	199 335 409	199 335 429	199 335 449	1.225
2000 - 20000	2 ½	65	199 335 010	199 335 030	199 335 050	2.639
3000 - 30000	2 ½	65	199 335 011	199 335 031	199 335 051	2.572
8000 - 60000	2 ½	65	199 335 012	199 335 032	199 335 052	2.432

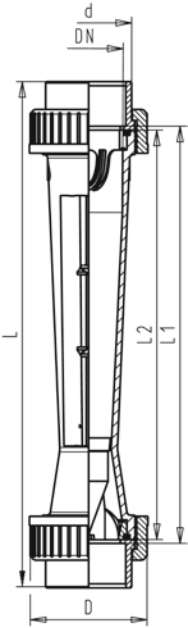

Scale range (l/h)	D (mm)	L (mm)	L1 (mm)	L2 (mm)
50 - 500	58	385	341	335
100 - 1000	58	385	341	335
150 - 1500	72	393	341	335
250 - 2500	72	393	341	335
200 - 2000	83	403	341	335
300 - 3000	83	403	341	335
600 - 6000	83	403	341	335
600 - 6000	101	417	341	335
1000 - 10000	101	417	341	335
1500 - 15000	101	417	341	335
2000 - 20000	135	429	341	335
3000 - 30000	135	429	341	335
8000 - 60000	135	429	341	335



Variable area flow meters
Float in PVDF with magnet
With solvent cement sockets PVC-U BS Inch

Model:

- Standard guiding rod PVDF with stainless steel core (V4A) for DN50 and DN65 see accessories for variable area flow meters

Scale range (L/h)	d (inch)	DN (mm)	Taper tube in PVC-U transp. O- rings in EPDM Code	Taper tube in Polyamid O-rings in EPDM Code	Taper tube in Polysulfone O-rings in EPDM Code	Weight (kg)
50 - 500	1	25	199 335 500	199 335 520	199 335 540	0.440
100 - 1000	1	25	199 335 501	199 335 521	199 335 541	0.440
150 - 1500	1 ¼	32	199 335 502	199 335 522	199 335 542	0.620
250 - 2500	1 ¼	32	199 335 503	199 335 523	199 335 543	0.620
200 - 2000	1 ½	40	199 335 504	199 335 524	199 335 544	0.900
300 - 3000	1 ½	40	199 335 505	199 335 525	199 335 545	0.900
600 - 6000	1 ½	40	199 335 506	199 335 526	199 335 546	0.900
600 - 6000	2	50	199 335 507	199 335 527	199 335 547	1.225
1000 - 10000	2	50	199 335 508	199 335 528	199 335 548	1.225
1500 - 15000	2	50	199 335 509	199 335 529	199 335 549	1.225
2000 - 20000	2 ½	65	199 335 110	199 335 130	199 335 150	2.441
3000 - 30000	2 ½	65	199 335 511	199 335 131	199 335 151	2.377
8000 - 60000	2 ½	65	199 335 112	199 335 132	199 335 152	2.150

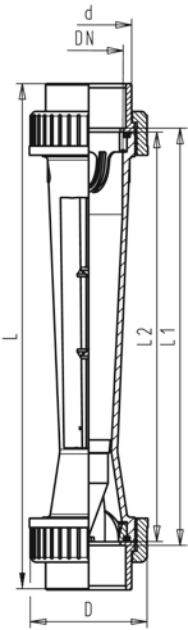

D (mm)	L (mm)	L1 (mm)	L2 (mm)
58	385	341	335
58	385	341	335
72	393	341	335
72	393	341	335
83	403	341	335
83	403	341	335
83	403	341	335
101	417	341	335
101	417	341	335
101	417	341	335
135	429	341	335
135	429	341	335
135	429	341	335



Variable area flow meters
Float in PVDF without magnet
With solvent cement sockets ABS metric

Model:

- Standard guiding rod PVDF with stainless steel core (V4A) for DN50 and DN65 see accessories for variable area flow meters

Scale range (l/h)	d (mm)	DN (mm)	Taper tube in Polyamid O-rings in EPDM Code	Weight (kg)	Taper tube in Polysulfone O-rings in EPDM Code	D (mm)	L (mm)	L1 (mm)	L2 (mm)
50 - 500	32	25	199 335 170	0.544	199 335 176	58	385	341	335
100 - 1000	32	25	199 335 171	0.544	199 335 177	58	385	341	335
300 - 3000	50	40	199 335 172	0.544	199 335 178	83	403	341	335
600 - 6000	50	40	199 335 173	0.900	199 335 179	83	403	341	335
1000 - 10000	63	50	199 335 174	1.370	199 335 180	101	417	341	335
1500 - 15000	63	50	199 335 175	1.370	199 335 181	101	417	341	335

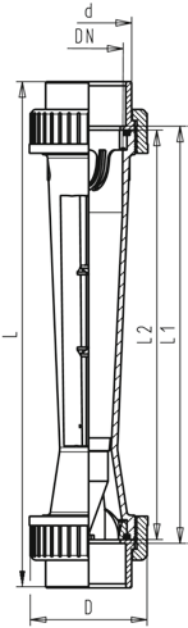



Variable area flow meters
Float in PVDF with magnet
With solvent cement sockets ABS metric

Model:

- Standard guiding rod PVDF with stainless steel core (V4A) for DN50 and DN65 see accessories for variable area flow meters

Scale range (L/h)	d (mm)	DN (mm)	Taper tube in Polyamid O-rings in EPDM Code	Weight (kg)	Taper tube in Polysulfone O-rings in EPDM Code	D (mm)	L (mm)	L1 (mm)	L2 (mm)
50 - 500	32	25	199 335 182	0.460	199 335 188	58	385	341	335
100 - 1000	32	25	199 335 183	0.460	199 335 189	58	385	341	335
300 - 3000	50	40	199 335 184	0.544	199 335 190	83	403	341	335
600 - 6000	50	40	199 335 185	0.900	199 335 191	83	403	341	335
1000 - 10000	63	50	199 335 186	1.370	199 335 192	101	417	341	335
1500 - 15000	63	50	199 335 187	1.758	199 335 193	101	417	341	335

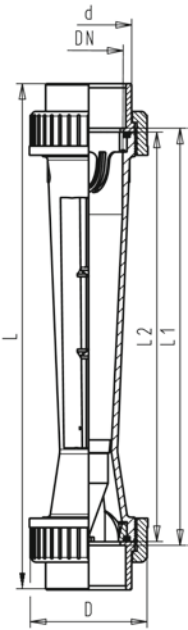



Variable area flow meters
Float in PVDF without magnet
With solvent cement sockets ABS BS Inch

Model:

- Standard guiding rod PVDF with stainless steel core (V4A) for DN50 and DN65 see accessories for variable area flow meters

Scale range (l/h)	d (inch)	DN (mm)	Taper tube in Polyamid O-rings in EPDM Code	Weight (kg)	Taper tube in Polysulfone O-rings in EPDM Code	L1 (mm)	D (mm)	L (mm)	L2 (mm)
50 - 500	1	25	199 335 300	0.450	199 335 301	341	58	385	335
100 - 1000	1	25	199 335 302	0.450	199 335 303	341	58	385	335
300 - 3000	1 ½	40	199 335 304	0.900	199 335 305	341	83	403	335
600 - 6000	1 ½	40	199 335 306	0.900	199 335 307	341	83	403	335
1000 - 10000	2	50	199 335 308	1.370	199 335 309	341	101	417	335
1500 - 15000	2	50	199 335 310	1.370	199 335 311	341	101	417	335

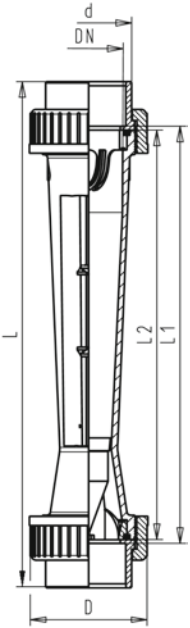



Variable area flow meters
Float in PVDF with magnet
With solvent cement sockets ABS BS Inch

Model:

- Standard guiding rod PVDF with stainless steel core (V4A) for DN50 and DN65 see accessories for variable area flow meters

Scale range (L/h)	d (inch)	DN (mm)	Taper tube in Polyamid O-rings in EPDM Code	Taper tube in Polysulfone O-rings in EPDM Code	Weight (kg)	D (mm)	L (mm)	L1 (mm)	L2 (mm)
50 - 500	1	25	199 335 312	199 335 313	0.480	58	385	341	335
100 - 1000	1	25	199 335 314	199 335 315	0.480	58	385	341	335
300 - 3000	1 ½	40	199 335 316	199 335 317	0.950	83	403	341	335
600 - 6000	1 ½	40	199 335 318	199 335 319	0.950	83	403	341	335
1000 - 10000	2	50	199 335 320	199 335 321	1.500	101	417	341	335
1500 - 15000	2	50	199 335 322	199 335 323	1.500	101	417	341	335

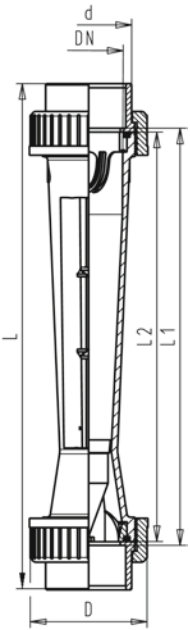

Variable Area Flow Meter Short Version



Short version
Float in PVDF without magnet
With solvent cement sockets PVC-U metric

Model:

- Union nuts and valve ends in other materials on request

Scale range (l/h)	Type	d (mm)	DN (mm)	Taper tube in Polysulfone O-rings in EPDM Code	Weight (kg)	Taper tube in PVC-U transp. O- rings in EPDM Code	Weight (kg)
2.5 - 25.0	SK 50	16	10	198 801 880	0.083	198 803 310	0.081
5.0 - 50.0	SK 51	16	10	198 801 881	0.078	198 803 311	0.079
10.0 - 100.0	SK 52	16	10	198 801 882	0.079	198 803 312	0.079
8.0 - 80.0	SK 60	20	15	198 801 883	0.125	198 803 313	0.127
15.0 - 150.0	SK 61	20	15	198 801 884	0.122	198 803 314	0.130
20.0 - 200.0	SK 62	20	15	198 801 885	0.119	198 803 315	0.125
15.0 - 150.0	SK 70	32	25	198 801 886	0.247	198 803 316	0.256
30.0 - 300.0	SK 71	32	25	198 801 887	0.244	198 803 317	0.254
50.0 - 500.0	SK 72	32	25	198 801 888	0.285	198 803 318	0.244
100.0 - 1000.0	SK 73	32	25	198 801 889	0.234	198 803 319	0.242

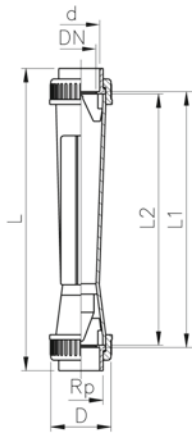

Scale range (l/h)	Type	D (mm)	L (mm)	L1 (mm)	L2 (mm)	G (inch)
2.5 - 25.0	SK 50	35	199	171	165	¾
5.0 - 50.0	SK 51	35	199	171	165	¾
10.0 - 100.0	SK 52	35	199	171	165	¾
8.0 - 80.0	SK 60	43	223	191	185	1
15.0 - 150.0	SK 61	43	223	191	185	1
20.0 - 200.0	SK 62	43	223	191	185	1
15.0 - 150.0	SK 70	60	250	206	200	1 ½
30.0 - 300.0	SK 71	60	250	206	200	1 ½
50.0 - 500.0	SK 72	60	250	206	200	1 ½
100.0 - 1000.0	SK 73	60	250	206	200	1 ½

Short version
Float in PVDF with magnet
With solvent cement sockets PVC-U metric

Model:

- Suitable limit switches see accessories for variable area flow meters
- Union nuts and valve ends in other materials on request

Scale range (l/h)	Type	d (mm)	DN (mm)	Taper tube in Polysulfone O-rings in EPDM Code	Weight (kg)	Taper tube in PVC-U transp. O- rings in EPDM Code	Weight (kg)
2.5 - 25.0	SK 500	16	10	198 801 890	0.079	198 803 320	0.081
5.0 - 50.0	SK 510	16	10	198 801 891	0.102	198 803 321	0.080
10.0 - 100.0	SK 520	16	10	198 801 892	0.075	198 803 322	0.079
8.0 - 80.0	SK 600	20	15	198 801 893	0.123	198 803 323	0.129
15.0 - 150.0	SK 610	20	15	198 801 894	0.121	198 803 324	0.160
20.0 - 200.0	SK 620	20	15	198 801 895	0.119	198 803 325	0.125
15.0 - 150.0	SK 700	32	25	198 801 896	0.248	198 803 326	0.301
30.0 - 300.0	SK 710	32	25	198 801 897	0.289	198 803 327	0.255
50.0 - 500.0	SK 720	32	25	198 801 898	0.241	198 803 328	0.248
100.0 - 1000.0	SK 730	32	25	198 801 899	0.280	198 803 329	0.242

Scale range (l/h)	Type	D (mm)	L (mm)	L1 (mm)	L2 (mm)	G (inch)
2.5 - 25.0	SK 500	35	199	171	165	¾
5.0 - 50.0	SK 510	35	199	171	165	¾
10.0 - 100.0	SK 520	35	199	171	165	¾
8.0 - 80.0	SK 600	43	223	191	185	1
15.0 - 150.0	SK 610	43	223	191	185	1
20.0 - 200.0	SK 620	43	223	191	185	1
15.0 - 150.0	SK 700	60	250	206	200	1 ½
30.0 - 300.0	SK 710	60	250	206	200	1 ½
50.0 - 500.0	SK 720	60	250	206	200	1 ½
100.0 - 1000.0	SK 730	60	250	206	200	1 ½



Short Version
Float in PVDF without magnet
With solvent cement sockets PVC-U BS Inch

Model:

- Union nuts and valve ends in other materials on request

Type	Scale range (l/h)	d (inch)	DN (mm)	Taper tube in Polysulfone O-rings in EPDM Code	Weight (kg)	Messrohr in PVC-U transp. O- Ringe aus EPDM Code	D (mm)	L (mm)	L1 (mm)	L2 (mm)
SK50	2.5 - 25	3/8	10	198 807 000	0.190	20014A290	35	199	171	165
SK51	5 - 50	3/8	10	198 807 001	0.190	20014A291	35	199	171	165
SK52	10 - 100	3/8	10	198 807 002	0.190	20014A292	35	199	171	165
SK60	8 - 80	1/2	15	198 807 003	0.260	20014A293	43	223	191	185
SK61	15 - 150	1/2	15	198 807 004	0.260	20014A294	43	223	191	185
SK62	20 - 200	1/2	15	198 807 005	0.260	20014A295	43	223	191	185
SK70	15 - 150	1	25	198 807 006	0.470	20014A296	60	250	206	200
SK71	30 - 300	1	25	198 807 007	0.470	20014A297	60	250	206	200
SK72	50 - 500	1	25	198 807 008	0.470	20014A298	60	250	206	200
SK73	100 - 1000	1	25	198 807 009	0.470	20014A299	60	250	206	200





Short Version
Float in PVDF with magnet
With solvent cement sockets PVC-U BS Inch

Type	Scale range (l/h)	d (inch)	DN (mm)	Taper tube in Polysulfone O-rings in EPDM Code	Weight (kg)	Messrohr in PVC-U transp. O- Ringe aus EPDM Code	D (mm)	L (mm)	L1 (mm)	L2 (mm)
SK500	2.5 - 25	3/8	10	198 807 010	0.180	20014A300	35	199	171	165
SK510	5 - 50	3/8	10	198 807 011	0.180	20014A301	35	199	171	165
SK520	10 - 100	3/8	10	198 807 012	0.180	20014A302	35	199	171	165
SK600	8 - 80	1/2	15	198 807 013	0.180	20014A303	43	223	191	185
SK610	15 - 150	1/2	15	198 807 014	0.250	20014A304	43	223	191	185
SK620	20 - 200	1/2	15	198 807 015	0.170	20014A305	43	223	191	185
SK700	15 - 150	1	25	198 807 016	0.470	20014A306	60	250	206	200
SK710	30 - 300	1	25	198 807 017	0.380	20014A307	60	250	206	200
SK720	50 - 500	1	25	198 807 018	0.370	20014A308	60	250	206	200
SK730	100 - 1000	1	25	198 807 019	0.370	20014A309	60	250	206	200

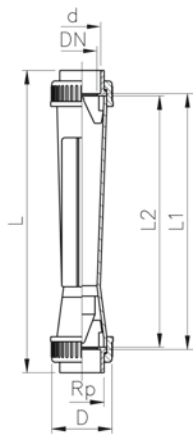

Short Version
Float in PVDF without magnet
With solvent cement sockets ABS metric

Model:

- Union nuts and valve ends in other materials on request

Type	Scale range (l/h)	d (mm)	DN (mm)	Taper tube in Polysulfone O-rings in EPDM Code	Weight (kg)	D (mm)	L (mm)	L1 (mm)	L2 (mm)
------	----------------------	-----------	------------	---	----------------	-----------	-----------	------------	------------

SK50	2.5 - 25	16	10	198 807 144	0.180	35	199	171	165
SK51	5 - 50	16	10	198 807 145	5.000	35	199	171	165
SK52	10 - 100	16	10	198 807 146	0.180	35	199	171	165
SK60	8 - 80	20	15	198 807 147	0.250	43	223	191	185
SK61	15 - 150	20	15	198 807 148	0.250	43	223	191	185
SK62	20 - 200	20	15	198 807 149	0.250	43	223	191	185
SK70	15 - 150	32	25	198 807 150	5.000	60	250	206	200
SK71	30 - 300	32	25	198 807 151	0.440	60	250	206	200
SK72	50 - 500	32	25	198 807 152	0.440	60	250	206	200
SK73	100 - 1000	32	25	198 807 153	5.000	60	250	206	200





Short Version
Float in PVDF with magnet
With solvent cement sockets ABS metric

Model:

- Suitable limit switches see accessories for variable area flow meters
- Union nuts and valve ends in other materials on request

Type	Scale range (l/h)	d (mm)	DN (mm)	Taper tube in Polysulfone O-rings in EPDM Code	Weight (kg)	D (mm)	L (mm)	L1 (mm)	L2 (mm)
SK500	2.5 - 25	16	10	198 807 154	0.180	35	199	171	165
SK510	5 - 50	16	10	198 807 155	0.180	35	199	171	165
SK520	10 - 100	16	10	198 807 156	0.180	35	199	171	165
SK600	8 - 80	20	15	198 807 157	0.260	43	223	191	185
SK610	15 - 150	20	15	198 807 158	0.260	43	223	191	185
SK620	20 - 200	20	15	198 807 159	0.260	43	223	191	185
SK700	15 - 150	32	25	198 807 160	0.444	60	250	206	200
SK710	30 - 300	32	25	198 807 161	0.444	60	250	206	200
SK720	50 - 500	32	25	198 807 162	0.444	60	250	206	200
SK730	100 - 1000	32	25	198 807 163	0.440	60	250	206	200

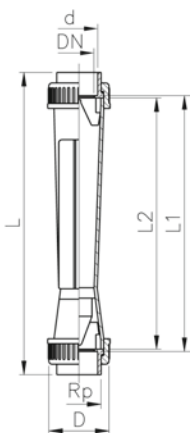

Short Version
Float in PVDF without magnet
With solvent cement sockets ABS BS Inch

Model:

- Union nuts and valve ends in other materials on request

Type	Scale range (l/h)	d (inch)	DN (mm)	Taper tube in Polysulfone O-rings in EPDM Code	Weight (kg)	D (mm)	L (mm)	L1 (mm)	L2 (mm)
------	----------------------	-------------	------------	---	----------------	-----------	-----------	------------	------------

SK50	2.5 - 25	3/8	10	198 807 040	0.180	35	199	171	165
SK51	5 - 50	3/8	10	198 807 041	0.180	35	199	171	165
SK52	10 - 100	3/8	10	198 807 042	0.180	35	199	171	165
SK60	8 - 80	1/2	15	198 807 043	0.250	43	223	191	185
SK61	15 - 150	1/2	15	198 807 044	0.250	43	223	191	185
SK62	20 - 200	1/2	15	198 807 045	0.120	43	223	191	185
SK70	15 - 150	1	25	198 807 046	0.440	60	250	206	200
SK71	30 - 300	1	25	198 807 047	5.000	60	250	206	200
SK72	50 - 500	1	25	198 807 048	0.280	60	250	206	200
SK73	100 - 1000	1	25	198 807 049	0.440	60	250	206	200

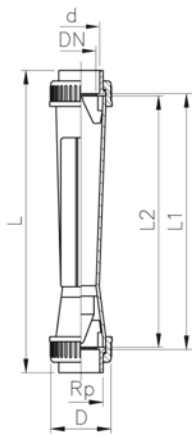

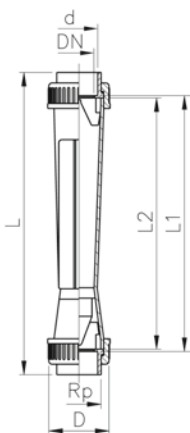

Short Version
Float in PVDF with magnet
With solvent cement sockets ABS BS Inch

Model:

- Suitable limit switches see accessories for variable area flow meters
- Union nuts and valve ends in other materials on request

Type	Scale range (l/h)	d (inch)	DN (mm)	Taper tube in Polysulfone O-rings in EPDM Code	Weight (kg)	D (mm)	L (mm)	L1 (mm)	L2 (mm)
SK500	2.5 - 25	3/8	10	198 807 050	0.180	35	199	171	165
SK510	5 - 50	3/8	10	198 807 051	0.180	35	199	171	165
SK520	10 - 100	3/8	10	198 807 052	0.180	35	199	171	165
SK600	8 - 80	1/2	15	198 807 053	0.170	43	223	191	185
SK610	15 - 150	1/2	15	198 807 054	0.250	43	223	191	185
SK620	20 - 200	1/2	15	198 807 055	0.170	43	223	191	185
SK700	15 - 150	1	25	198 807 056	0.440	60	250	206	200
SK710	30 - 300	1	25	198 807 057	0.350	60	250	206	200
SK720	50 - 500	1	25	198 807 058	0.340	60	250	206	200
SK730	100 - 1000	1	25	198 807 059	0.340	60	250	206	200

Variable Area Flow Meter Special Version



Special version Type 335 PVDF-HP
 Float in PVDF (white) without magnet
 With fusion spigots BCF/IR

d (mm)	DN (mm)	Scale range (l/h)	Scale range (gal/min)	Taper tube in Polysulfone O-rings in FKM (white) Code	Weight (kg)	D (mm)	L (mm)	L2 (mm)	G (inch)
32	25	100 - 1000	0.4 - 4.4	198 335 160	0.401	60	453	335	1 ½
50	40	300 - 3000	1.3 - 13.2	198 335 161	1.030	83	466	335	2 ¼
50	40	600 - 6000	2.6 - 26.4	198 335 162	0.978	83	466	335	2 ¼
63	50	1000 - 8000	4.4 - 35.2	198 335 163	1.500	103	472	335	2 ¾
63	50	1500 - 15000	6.6 - 66.0	198 335 164	1.500	103	472	335	2 ¾
75	65	2000 - 20000	8.8 - 88.0	198 335 165	2.500	122	495	335	3 ½
75	65	3000 - 29000	13.2 - 127.7	198 335 166	2.500	122	495	335	3 ½

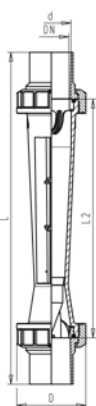

Special version PVDF-HP
Float in PTFE without magnet
With fusion spigots BCF/IR



Type	d (mm)	DN (mm)	Scale range (l/h)	Scale range (gal/min)	Taper tube in Polysulfone O-rings in FKM Code	Weight (kg)	D (mm)	L (mm)	L2 (mm)	G (inch)
SK 70	32	25	68 - 204	0.3 - 0.9	198 807 209	0.383	60	318	200	1 ½
SK 71	32	25	90 - 295	0.4 - 1.3	198 807 210	0.387	60	318	200	1 ½
SK 73	32	25	136 - 795	0.6 - 3.5	198 807 202	0.401	60	318	200	1 ½

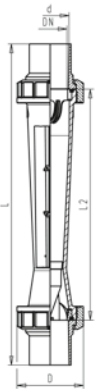

Accessories

Accessories 4-20 mA sensor For type 335 and type 350

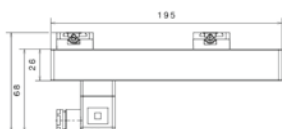
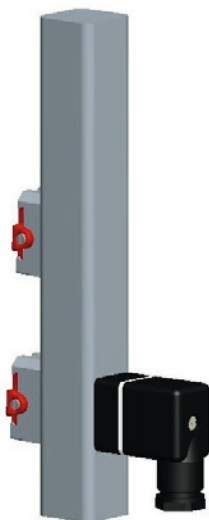

Type	d (mm)	DN (mm)	Corresponds to water scale (L/h)	Code	Weight (kg)
GK 15	32	25	50-500	199 335 962	0.150
GK 15	32	25	100-1000	199 335 963	0.150
GK 15	40	32	150-1500	199 335 964	0.150
GK 15	40	32	250-2500	199 335 965	0.150
GK 15	50	40	200-2000	199 335 966	0.150
GK 15	50	40	300-3000	199 335 967	0.150
GK 15	50	40	600-6000	199 335 968	0.150
GK 15	63	50	600-6000	199 335 969	0.150
GK 15	63	50	1000-10000	199 335 991	0.150
GK 15	63	50	1500-15000	199 335 992	0.120
GK 15	75	65	2000-20000	199 335 993	0.150
GK 15	75	65	3000-30000	199 335 994	0.150
GK 15	75	65	8000-60000	199 335 995	0.150

Accessories Limit contacts GK10/GK11 For type 335/350 and short version

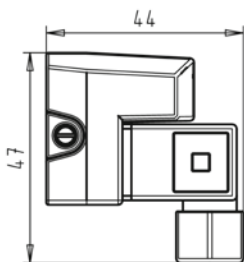
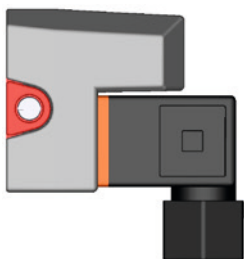

Type	Code	Weight (kg)
GK10 (min.)	198 335 998	0.035
GK11 (max.)	198 335 999	0.034

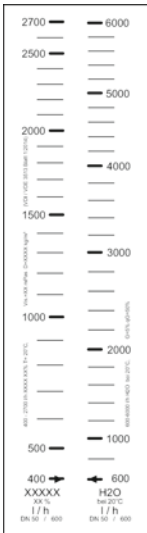

Example of special scale

Special scale for type 335/350 % for H2O

d (mm)	DN (mm)	Scale range (L/h)	Corresponds to water scale (L/h)	Code	Weight (kg)
32	25	10-100 %	50-500	199 335 084	0.050
32	25	10-100 %	100-1000	199 335 083	0.003
40	32	10-100 %	150-1500	199 335 069	0.050
40	32	10-100 %	250-2500	199 335 068	0.050
50	40	10-100 %	200-2000	199 335 054	0.050
50	40	10-100 %	300-3000	199 335 053	0.002
50	40	10-100 %	600-6000	199 335 039	0.050
63	50	10-100 %	600-6000	199 335 038	0.002
63	50	10-100 %	1000-10000	199 335 037	0.002
63	50	10-100 %	1500-15000	199 335 036	0.050
75	65	10-100 %	2000-20000	199 335 035	0.050
75	65	10-100 %	3000-30000	199 335 034	0.050
75	65	13.3-100 %	8000-60000	199 335 033	0.050

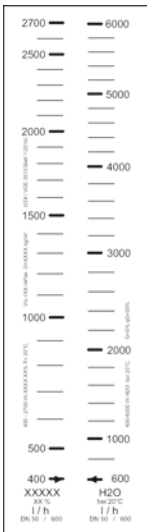

Example of special scale

Special scale for type 335/350 m³/h

d (mm)	DN (mm)	Scale range (m ³ /h)	Corresponds to water scale (L/h)	Code	Weight (kg)
32	25	0.05 - 0.50	50 - 500	199 335 655	0.050
32	25	0.10 - 1.00	100 - 1000	199 335 656	0.050
40	32	0.15 - 1.50	150 - 1500	199 335 657	0.050
40	32	0.25 - 2.50	250 - 2500	199 335 658	0.050
50	40	0.20 - 2.00	200 - 2000	199 335 659	0.050
50	40	0.30 - 3.00	300 - 3000	199 335 660	0.050
50	40	0.60 - 6.00	600 - 6000	199 335 661	0.050
63	50	0.60 - 6.00	600 - 6000	199 335 662	0.050
63	50	1.00 - 10.00	1000 - 10000	199 335 663	0.050
63	50	1.50 - 15.00	1500 - 15000	199 335 664	0.050
75	65	2.00 - 20.00	2000 - 20000	199 335 665	0.050
75	65	3.00 - 30.00	3000 - 30000	199 335 666	0.008
75	65	8.00 - 60.00	8000 - 60000	199 335 667	0.050

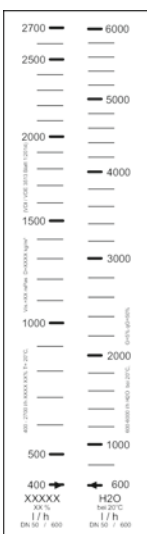

Example of special scale

Special scale for type 335/350 Imp. GPM

d (mm)	DN (mm)	Scale range (gal/min)	Corresponds to water scale (L/h)	Code	Weight (kg)
32	25	0.183 - 1.830	50-500	199 335 670	0.050
32	25	0.366 - 3.660	100-1000	199 335 671	0.050
40	32	0.550 - 5.500	150-1500	199 335 672	0.050
40	32	0.916 - 9.160	250-2500	199 335 673	0.050
50	40	0.733 - 7.330	200-2000	199 335 674	0.050
50	40	1.090 - 10.900	300-3000	199 335 675	0.050
50	40	2.190 - 21.900	600-6000	199 335 676	0.050
63	50	2.200 - 22.000	600-6000	199 335 677	0.050
63	50	3.660 - 36.600	1000-10000	199 335 678	0.050
63	50	5.490 - 54.900	1500-15000	199 335 679	0.050
75	65	7.320 - 73.200	2000-20000	199 335 680	0.050
75	65	10.980 - 109.800	3000-30000	199 335 681	0.050
75	65	29.280 - 219.600	8000-60000	199 335 682	0.050

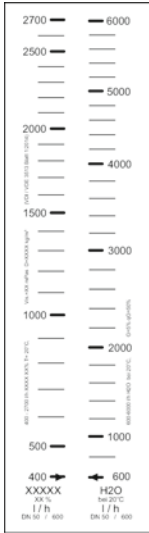

Special scale for type 335/350 US GPM

d (mm)	DN (mm)	Scale range (gal/min)	Corresponds to water scale (l/h)	Code	Weight (kg)
32	25	0.22 - 2.20	50 - 500	199 335 685	0.050
32	25	0.44 - 4.40	100 - 1000	199 335 686	0.050
40	32	0.66 - 6.60	150 - 1500	199 335 687	0.002
40	32	1.10 - 11.00	250 - 2500	199 335 688	0.050
50	40	0.88 - 8.80	200 - 2000	199 335 689	0.002
50	40	1.32 - 13.20	300 - 3000	199 335 690	0.050
50	40	2.64 - 26.40	600 - 6000	199 335 691	0.002
63	50	2.64 - 26.40	600 - 6000	199 335 692	0.050
63	50	4.40 - 44.02	1000 - 10000	199 335 693	0.002
63	50	6.60 - 66.04	1500 - 15000	199 335 694	0.050
75	65	8.80 - 88.00	2000 - 20000	199 335 695	0.002
75	65	13.20 - 132.00	3000 - 30000	199 335 696	0.002
75	65	35.20 - 264.00	8000 - 60000	199 335 697	0.050

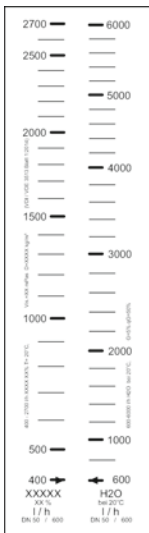

Special scale for type 335/350 l/h

d (mm)	DN (mm)	Scale range (l/h)	Code	Weight (kg)
32	25	50 - 500	199 335 861	0.050
32	25	100 - 1000	199 335 862	0.050
40	32	150 - 1500	199 335 863	0.050
40	32	250 - 2500	199 335 864	0.050
50	40	200 - 2000	199 335 865	0.050
50	40	600 - 6000	199 335 867	0.050
50	40	300 - 3000	199 335 866	0.050
63	50	600 - 6000	199 335 868	0.050
63	50	1000 - 10000	199 335 869	0.050
63	50	1500 - 15000	199 335 870	0.050
75	65	2000 - 20000	199 335 871	0.050
75	65	3000 - 30000	199 335 872	0.050
75	65	8000 - 60000	199 335 873	0.050

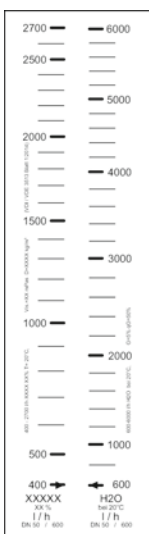

Special scale for type 335/350 Air/0bar/Nm3/h

d (mm)	DN (mm)	Scale range (m³/h)	Corresponds to water scale (l/h)	Code	Weight (kg)
32	25	2.0 - 15.0	50 - 500	199 350 655	0.002
32	25	3.5 - 30.0	100 - 1000	199 350 656	0.050
40	32	5.0 - 45.0	150 - 1500	199 350 657	0.050
40	32	8.0 - 76.0	250 - 2500	199 350 658	0.050
50	40	7.0 - 60.0	200 - 2000	199 350 659	0.050
50	40	10.0 - 87.0	300 - 3000	199 350 660	0.002
50	40	20.0 - 170.0	600 - 6000	199 350 661	0.050
63	50	25.0 - 180.0	600 - 6000	199 350 662	0.050
63	50	30.0 - 280.0	1000 - 10000	199 350 663	0.050
63	50	50.0 - 440.0	1500 - 15000	199 350 664	0.050
75	65	70.0 - 580.0	2000 - 20000	199 350 665	0.050
75	65	10.0 - 900.0	3000 - 30000	199 350 666	0.050
75	65	230.0 - 1650.0	8000 - 60000	199 350 667	0.050

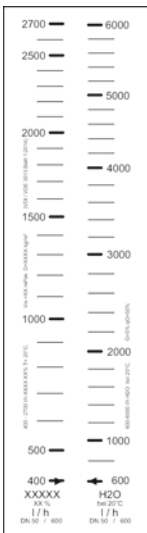

Special scale for type 335/350 HCl 30-33% l/h

d (mm)	DN (mm)	Scale range (l/h)	Corresponds to water scale (l/h)	Code	Weight (kg)
32	25	40 - 430	50-500	199 350 670	0.050
32	25	80 - 860	100-1000	199 350 671	0.002
40	32	150 - 1250	150-1500	199 350 672	0.050
40	32	200 - 2150	250-2500	199 350 673	0.050
50	40	200 - 1850	200-2000	199 350 674	0.050
50	40	300 - 2500	300-3000	199 350 675	0.050
50	40	600 - 4900	600-6000	199 350 676	0.010
63	50	600 - 5400	600-6000	199 350 677	0.050
63	50	800 - 8400	1000-10000	199 350 678	0.050
63	50	1000 - 12750	1500-15000	199 350 679	0.050
75	65	2000 - 17500	2000-20000	199 350 680	0.050
75	65	3000 - 26500	3000-30000	199 350 681	0.050
75	65	6000 - 50000	8000-60000	199 350 682	0.050

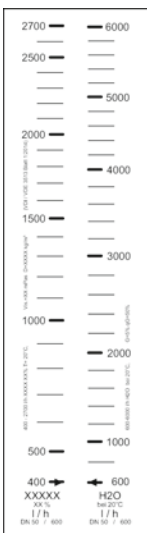

Special scale for type 335/350 NaOH 30% l/h

d (mm)	DN (mm)	Scale range (l/h)	Corresponds to water scale (l/h)	Code	Weight (kg)
32	25	30 - 320	50-500	199 350 685	0.050
32	25	70 - 660	100-1000	199 350 686	0.050
40	32	100 - 900	150-1500	199 350 687	0.050
40	32	100 - 1600	250-2500	199 350 688	0.050
50	40	200 - 1400	200-2000	199 350 689	0.002
50	40	300 - 1950	300-3000	199 350 690	0.050
50	40	500 - 3800	600-6000	199 350 691	0.050
63	50	500 - 4300	600-6000	199 350 692	0.050
63	50	600 - 6600	1000-10000	199 350 693	0.050
63	50	750 - 9500	1500-15000	199 350 694	0.050
75	65	1300 - 13000	2000-20000	199 350 695	0.050
75	65	2600 - 20000	3000-30000	199 350 696	0.050
75	65	6000 - 40000	8000-60000	199 350 697	0.050

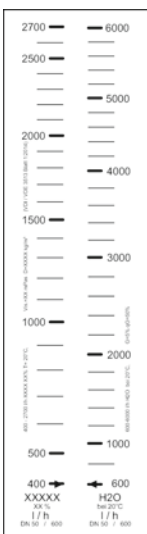

Special scale for type 335/350 NaOH 50% l/h

d (mm)	DN (mm)	Scale range (l/h)	Corresponds to water scale (l/h)	Code	Weight (kg)
32	25	10 - 62	50-500	199 350 755	0.050
32	25	10 - 195	100-1000	199 350 756	0.050
40	32	20 - 350	150-1500	199 350 757	0.050
40	32	5 - 760	250-2500	199 350 758	0.050
50	40	5 - 540	200-2000	199 350 759	0.050
50	40	105 - 1200	300-3000	199 350 760	0.050
50	40	400 - 2350	600-6000	199 350 761	0.002
63	50	100 - 2200	600-6000	199 350 762	0.050
63	50	100 - 4000	1000-10000	199 350 763	0.050
63	50	300 - 5000	1500-15000	199 350 764	0.050
75	65	200 - 7000	2000-20000	199 350 765	0.050
75	65	400 - 9800	3000-30000	199 350 766	0.050
75	65	2000 - 15000	8000-60000	199 350 767	0.050

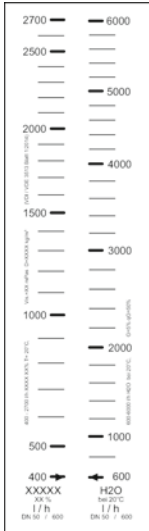

Example of special scale

Special scale for short version Water l/h

Type	Scale range (l/h)	Code
SK 50 / 500	2.5 - 25.0	198 801 386
SK 51 / 510	5.0 - 50.0	198 801 387
SK 52 / 520	10.0 - 100.0	198 801 388
SK 60 / 600	8.0 - 80.0	198 801 389
SK 61 / 610	15.0 - 150.0	198 801 390
SK 62 / 620	20.0 - 200.0	198 801 391
SK 70 / 700	15.0 - 150.0	198 801 392
SK 71 / 710	30.0 - 30.0	198 801 393
SK 72 / 720	50.0 - 500.0	198 801 394
SK 73 / 730	100.0 - 1000.0	198 801 395

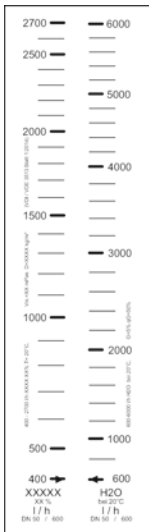

Example of special scale

Special scale for short version US GPM

Type	Scale range (gal/min)	Code
SK 50 / 500	0.01 - 0.11	198 801 961
SK 51 / 510	0.02 - 0.22	198 801 962
SK 52 / 520	0.04 - 0.44	198 801 963
SK 60 / 600	0.03 - 0.35	198 801 964
SK 61 / 610	0.06 - 0.66	198 801 965
SK 62 / 620	0.08 - 0.88	198 801 966
SK 70 / 700	0.06 - 0.66	198 801 967
SK 71 / 710	0.13 - 1.32	198 801 968
SK 72 / 720	0.22 - 2.20	198 801 969
SK 73 / 730	0.44 - 4.40	198 801 970

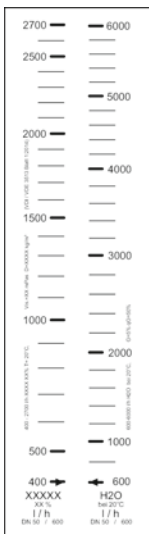

Example of special scale

Special scale for short version Air/0bar/Nm³/h

Type	Scale range (m ³ /h)	Code
SK 50 / 500	0.50 - 0.95	198 801 308
SK 51 / 510	0.50 - 1.90	198 801 309
SK 52 / 520	0.80 - 3.00	198 801 310
SK 60 / 600	0.60 - 2.80	198 801 311
SK 61 / 610	1.40 - 5.60	198 801 312
SK 62 / 620	1.50 - 7.00	198 801 313
SK 70 / 700	1.00 - 6.50	198 801 314
SK 71 / 710	1.50 - 11.00	198 801 315
SK 72 / 720	3.00 - 18.00	198 801 316
SK 73 / 730	6.00 - 30.00	198 801 317

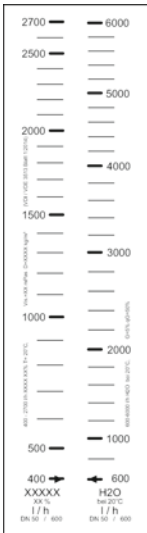

Example of special scale

Special scale for short version HCl 30 - 33% l/h

Type	Scale range (l/h)	Code
SK 50 / 500	2.5 - 20.0	198 806 511
SK 51 / 510	5.0 - 40.0	198 806 512
SK 52 / 520	10.0 - 85.0	198 806 513
SK 60 / 600	8.0 - 70.0	198 806 514
SK 61 / 610	15.0 - 125.0	198 806 515
SK 62 / 620	20.0 - 170.0	198 806 516
SK 70 / 700	5.0 - 125.0	198 806 517
SK 71 / 710	30.0 - 260.0	198 806 518
SK 72 / 720	50.0 - 425.0	198 806 519
SK 73 / 730	100.0 - 850.0	198 806 520

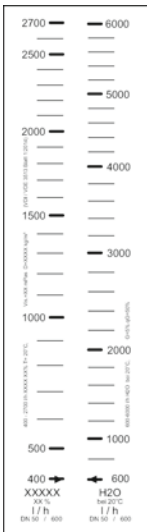

Example of special scale

Special scale for short version NaOH 30% l/h

Type	Scale range (l/h)	Code
SK 50 / 500	0.2 - 5.0	198 806 521
SK 51 / 510	1.0 - 14.0	198 806 522
SK 52 / 520	3.0 - 35.0	198 806 523
SK 60 / 600	2.0 - 23.0	198 806 524
SK 61 / 610	3.0 - 55.0	198 806 525
SK 62 / 620	5.0 - 80.0	198 806 526
SK 70 / 700	3.0 - 55.0	198 806 527
SK 71 / 710	6.0 - 130.0	198 806 528
SK 72 / 720	10.0 - 250.0	198 806 529
SK 73 / 730	40.0 - 590.0	198 806 530

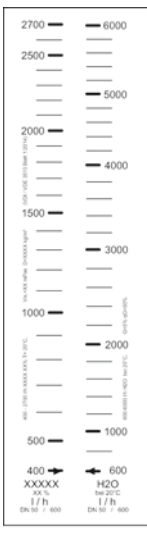

Example of special scale

Special scale for short version NaOH 50% l/h

Type	Scale range (l/h)	Code
SK 60 / 600	0.2 - 3.5	198 806 531
SK 61 / 610	0.5 - 10.0	198 806 532
SK 62 / 620	0.5 - 16.0	198 806 533
SK 70 / 700	0.5 - 11.0	198 806 534
SK 71 / 710	1.0 - 33.0	198 806 535
SK 72 / 720	2.0 - 80.0	198 806 536
SK 73 / 730	10.0 - 220.0	198 806 537

Spare Parts for Type 335

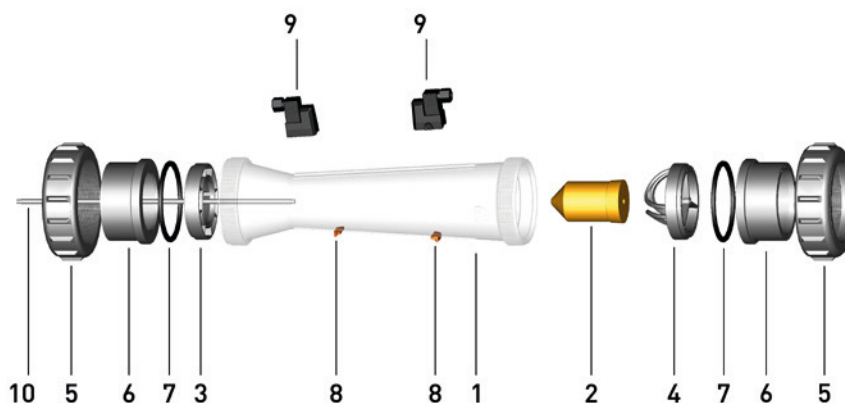

Taper tube Type 335 with water scale (1)



d (mm)	Size (inch)	DN (mm)	Scale range (l/h)	PVC-U transparent Code	Polyamid Code	Polysulfone Code
32	1	25	50 - 500	199 335 055	199 335 070	199 335 085
32	1	25	100 - 1000	199 335 056	199 335 071	199 335 086
40	1 ¼	32	150 - 1500	199 335 057	199 335 072	199 335 087
40	1 ¼	32	250 - 2500	199 335 058	199 335 073	199 335 088
50	1 ½	40	200 - 2000	199 335 059	199 335 074	199 335 089
50	1 ½	40	300 - 3000	199 335 060	199 335 075	199 335 090
50	1 ½	40	600 - 6000	199 335 061	199 335 076	199 335 091
63	2	50	600 - 6000	199 335 062	199 335 077	199 335 092
63	2	50	1000 - 10000	199 335 063	199 335 078	199 335 093
63	2	50	1500 - 15000	199 335 064	199 335 079	199 335 094
75	2 ½	65	2000 - 20000	199 335 065	199 335 080	199 335 095
75	2 ½	65	3000 - 30000	199 335 066	199 335 081	199 335 096
75	2 ½	65	8000 - 60000	199 335 067	199 335 082	199 335 097

Taper tube Type 335 without scale (1)



Scale range (l/h)	d (mm)	Size (inch)	DN (mm)	PVC-U transparent Code	Polyamid Code	Polysulfone Code
50 - 500	32	1	25	199 335 255	199 335 270	199 335 285
100 - 1000	32	1	25	199 335 256	199 335 271	199 335 286
150 - 1500	40	1 ¼	32	199 335 257	199 335 272	199 335 287
250 - 2500	40	1 ¼	32	199 335 258	199 335 273	199 335 288
200 - 2000	50	1 ½	40	199 335 259	199 335 274	199 335 289
300 - 3000	50	1 ½	40	199 335 260	199 335 275	199 335 290
600 - 6000	50	1 ½	40	199 335 261	199 335 276	199 335 291
600 - 6000	63	2	50	199 335 262	199 335 277	199 335 292
1000 - 10000	63	2	50	199 335 263	199 335 278	199 335 293
1500 - 15000	63	2	50	199 335 264	199 335 279	199 335 294
2000 - 20000	75	2 ½	65	199 335 265	199 335 280	199 335 295
3000 - 30000	75	2 ½	65	199 335 266	199 335 281	199 335 296
8000 - 60000	75	2 ½	65	199 335 267	199 335 282	199 335 297

Float PVDF (2)



DN50

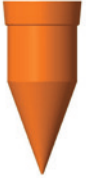

DN40



DN65

d (mm)	Size (inch)	DN (mm)	Scale range (l/h)	Without magnet Code	With magnet (bistabil) Code
32	1	25	50 - 500	198 335 455	198 335 470
32	1	25	100 - 1000	198 335 455	198 335 470
40	1 ¼	32	150 - 1500	198 335 455	198 335 470
40	1 ¼	32	250 - 2500	198 335 455	198 335 470
50	1 ½	40	200 - 2000 / 300 - 3000 / 600 - 6000	198 335 457	198 335 471
63	2	50	600 - 6000 / 1000 - 10000 / 1500 - 15000	198 335 458	198 335 472
75	2 ½	65	2000 - 20000	198 335 459	198 335 473
75	2 ½	65	3000 - 30000	198 335 459	198 335 473
75	2 ½	65	8000 - 60000	199 335 460	199 335 474

Insert PVDF (3,4)



top



bottom

DN25 - DN40

d (mm)	Size (inch)	DN (mm)	Scale range (l/h)	top (4) Code	bottom (3) Code
32	1	25	50 - 500	198 335 970	198 335 977
40	1 ¼	32	150 - 1500, 250 - 2500	198 335 971	198 335 978
50	1 ½	40	200 - 2000, 300 - 3000, 600 - 6000	198 335 972	198 335 979
63	2	50	600-6000, 1000-10000, 1500-15000	199 335 974	198 335 893
75	2 ½	65	2000-20000, 3000-30000, 8000-60000	199 335 975	198 335 894



Union nut (5)

d (mm)	Size (inch)	DN (mm)	PVC-U Code	PVC-C Code	ABS Code	PP-H Code	PVDF Code
32	1	25	721 890 008	723 690 008	729 890 408	727 890 408	735 690 408
40	1 ¼	32	721 890 009	723 690 009	729 890 409	727 890 409	735 690 409
50	1 ½	40	721 890 010	723 690 010	729 890 410	727 890 410	735 690 410
63	2	50	721 890 011	723 690 011	729 890 411	727 890 411	735 690 411
75	2 ½	65	198 806 429			198 806 421	198 806 422



Union end / Socket (6)

For DN65 PVDF only spigot

d (mm)	Size (inch)	DN (mm)
32	1	25
40	1 ¼	32
50	1 ½	40
63	2	50
75	2 ½	65

d (mm)	PVC-U Code	PVC-C Code	ABS Code	PP-H Code	PVDF Code	PE80 Code
32	721 500 108	723 800 108	729 800 108	727 500 108	735 600 108	734 600 108
40	721 500 109	723 800 109	729 800 109	727 500 109	735 600 109	734 600 109
50	721 500 110	723 800 110	729 800 110	727 500 110	735 600 110	734 600 110
63	721 500 111	723 800 111	729 800 111	727 500 111	735 600 111	734 600 111
75	721 600 112	700 253 867	700 246 112	700 253 866		700 246 419

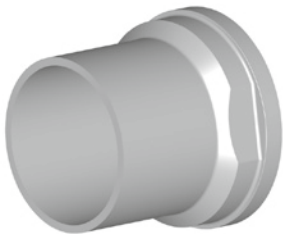

Union end / Spigot (6)

d (mm)	Size (inch)	DN (mm)	PP-H Code	PVDF Code	PE100 Code
32	1	25	727 508 508	735 608 608	753 508 608
40	1 ¼	32	727 508 509	735 608 609	753 508 609
50	1 ½	40	727 508 510	735 608 610	753 508 610
63	2	50	727 508 511	735 608 611	753 508 611
75	2 ½	65	700 256 401	175 483 013	700 246 420



O-rings (7)

d (mm)	Size (inch)	DN (mm)	EPDM Code	FKM Code
32	1	25	748 410 008	749 410 008
40	1 ¼	32	748 410 009	749 410 009
50	1 ½	40	748 410 010	749 410 010
63	2	50	748 410 011	749 410 011
75	2 ½	65	748 410 014	749 410 014

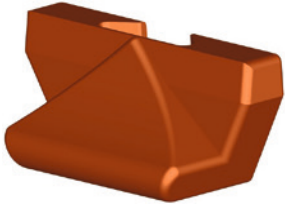

Flow value indicator PS (8)

Model:

- For all dimensions type 335/350

d (mm)	Size (inch)	DN (mm)	Flow value indicator Code
32	1	25	198 335 990
40	1 ¼	32	198 335 990
50	1 ½	40	198 335 990
63	2	50	198 335 990
75	2 ½	65	198 335 990



Guiding rod (10)

d (mm)	Size (inch)	Scale range (L/h)	PVDF Code
63	2	600-6000, 1000-10000, 1500-15000	198 335 984
75	2 ½	2000-20000, 3000-30000, 8000-60000	198 335 984



Insert guiding rod PVDF (for 10)

d (mm)	Size (inch)	DN (mm)	Scale range (L/h)	Code
63	2	50	600-6000, 1000-10000, 1500-15000	198 335 953
75	2 ½	65	2000-20000, 3000-30000, 8000-60000	198 335 954



Guiding rod

Model:

- Exchange kit consisting of: guiding rod (10), insert guiding rod (for 10) and insert bottom (3)
- Exchange Kit to exchange PEEK and stainless steel guiding rods

d (mm)	Size (inch)	DN (mm)	Scale range (L/h)	PVDF Code
63	2	50	600-6000, 1000-10000, 1500-15000	199 335 895
75	2 ½	65	2000-20000, 3000-30000, 8000-60000	199 335 896

Spare Parts for Variable Area Flow Meter Short Version Type SK50-SK73/ SK500-SK730



Short version taper tube Polysulfone

d (mm)	DN (mm)	Type	Code
16	10	SK 50 / 500	198 801 341
16	10	SK 51 / 510	198 801 342
16	10	SK 52 / 520	198 801 343
20	15	SK 60 / 600	198 801 449
20	15	SK 61 / 610	198 801 450
20	15	SK 62 / 620	198 801 451
32	25	SK 70 / 700	198 801 445
32	25	SK 71 / 710	198 801 338
32	25	SK 72 / 720	198 801 339
32	25	SK 73 / 730	198 801 340

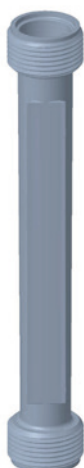

Short version taper tube PVC-U transparent

d (mm)	DN (mm)	Type	Code
16	10	SK 50 / 500	198 803 790
16	10	SK 51 / 510	198 803 791
16	10	SK 52 / 520	198 803 792
20	15	SK 60 / 600	198 803 793
20	15	SK 61 / 610	198 803 794
20	15	SK 62 / 620	198 803 795
32	25	SK 70 / 700	198 803 796
32	25	SK 71 / 710	198 803 797
32	25	SK 72 / 720	198 803 798
32	25	SK 73 / 730	198 803 799



Short version float PVDF Without magnet

d (mm)	DN (mm)	Type	Code
16	10	SK 50 / 51 / 52	198 806 219
20	15	SK 60 / 61 / 62	198 806 220
32	25	SK 70 / 71 / 72 / 73	198 806 221

**Short version float PVDF
With magnet bistable**



d (mm)	DN (mm)	Type	Code
16	10	SK 500 / 510 / 520	198 806 222
20	15	SK 600 / 610 / 620	198 806 223
32	25	SK 700 / 710 / 720 / 730	198 806 224

**Short version float PTFE
Without magnet**



d (mm)	DN (mm)	Type	Code
32	25	SK 73	198 807 166

Short version top insert PVDF



d (mm)	DN (mm)	Type	Code
16	10	SK 50 / 500; 51 / 510; 52 / 520	198 807 188
20	15	SK 60 / 600; 61 / 610; 62 / 620	198 807 187
32	25	SK 70 / 700; 71 / 710; 72 / 720; 73 / 730	198 807 182

Worldwide at home

Our sales companies and representatives ensure local customer support in more than 100 countries.

www.gfps.com

Argentina / Southern South America

Georg Fischer Central Plastics Sudamérica S.R.L.
Buenos Aires / Argentina
Phone +54 11 4512 02 90
gfccentral.ps.ar@georgfischer.com
www.gfps.com/ar

Australia

George Fischer Pty Ltd
Riverwood NSW 2210
Phone +61 (0) 2 9502 8000
australia.ps@georgfischer.com
www.gfps.com/au

Austria

Georg Fischer Rohrleitungssysteme GmbH
3130 Herzogenburg
Phone +43 (0) 2782 856 43-0
austria.ps@georgfischer.com
www.gfps.com/at

Belgium / Luxembourg

Georg Fischer NV/SA
1600 Sint-Pieters-Leeuw / Belgium
Phone +32 (0) 2 556 40 20
Fax +32 (0) 2 524 34 26
be.ps@georgfischer.com
www.gfps.com/be

Brazil

Georg Fischer Sist. de Tub. Ltda.
04571-020 São Paulo/SP
Phone +55 (0) 11 5525 1311
br.ps@georgfischer.com
www.gfps.com/br

Canada

Georg Fischer Piping Systems Ltd
Mississauga, ON L5T 2B2
Phone +1 (905) 670 8005
Fax +1 (905) 670 8513
ca.ps@georgfischer.com
www.gfps.com/ca

China

Georg Fischer Piping Systems Ltd
Shanghai 201319
Phone +86 21 3899 3899
china.ps@georgfischer.com
www.gfps.com/cn

Denmark / Iceland

Georg Fischer A/S
2630 Taastrup / Denmark
Phone +45 (0) 70 22 19 75
info.dk.ps@georgfischer.com
www.gfps.com/dk

Finland

Georg Fischer AB
01510 Vantaa
Phone +358 (0) 9 586 58 25
Fax +358 (0) 9 586 58 29
info.fi.ps@georgfischer.com
www.gfps.com/fin

France

Georg Fischer SAS
95932 Roissy Charles de Gaulle Cedex
Phone +33 (0) 1 41 84 68 84
fr.ps@georgfischer.com
www.gfps.com/fr

Germany

Georg Fischer GmbH
73095 Albershausen
Phone +49 (0) 7161 302 0
info.de.ps@georgfischer.com
www.gfps.com/de

India

Georg Fischer Piping Systems Pvt. Ltd
400 083 Mumbai
Phone +91 22 4007 2000
Fax +91 22 4007 2020
branchoffice@georgfischer.com
www.gfps.com/in

Indonesia

PT Georg Fischer Indonesia
Karawang 41371, Jawa Barat
Phone +62 267 432 044
Fax +62 267 431 857
indonesia.ps@georgfischer.com
www.gfps.com/id

Italy

Georg Fischer S.p.A.
20864 Agrate Brianza (MB)
Phone +39 02 921 86 1
Fax +39 02 921 86 24 7
it.ps@georgfischer.com
www.gfps.com/it

Japan

Georg Fischer Ltd
530-0003 Osaka
Phone +81 (0) 6 6341 2451
jp.ps@georgfischer.com
www.gfps.com/jp

Korea

Georg Fischer Korea Co. Ltd
Unit 2501, U-Tower
120 Heungdeok Jungang-ro
(Yeongdeok-dong)
Giheung-gu, Yongin-si, Gyeonggi-do
Phone +82 31 8017 1450
Fax +82 31 217 1454
kor.ps@georgfischer.com
www.gfps.com/kr

Malaysia

Georg Fischer (M) Sdn. Bhd.
41200 Klang, Selangor Darul Ehsan
Phone +60 (0) 3 3122 5585
Fax +60 (0) 3 3122 5575
my.ps@georgfischer.com
www.gfps.com/my

Mexico / Northern Latin America

Georg Fischer S.A. de C.V.
CP 66603 Apodaca, Nuevo León / Mexico
Phone +52 (81) 1340 8586
Fax +52 (81) 1522 8906
mx.ps@georgfischer.com
www.gfps.com/mx

Middle East

Georg Fischer Piping Systems (Switzerland) Ltd
Dubai / United Arab Emirates
Phone +971 4 289 49 60
gcc.ps@georgfischer.com
www.gfps.com/int

Netherlands

Georg Fischer N.V.
8161 PA Epe
Phone +31 (0) 578 678 222
nl.ps@georgfischer.com
www.gfps.com/nl

New Zealand

Georg Fischer Ltd
5018 Upper Hutt
Phone +04 527 9813
Fax +04 527 9834
nz.ps@georgfischer.com
www.gfps.com/nz

Norway

Georg Fischer AS
1351 Rud
Phone +47 67 18 29 00
no.ps@georgfischer.com
www.gfps.com/no

Philippines

George Fischer Pte. Ltd.
Philippines Representative Office
1500 San Juan City
Phone +632 571 2365
Fax +632 571 2368
sgp.ps@georgfischer.com
www.gfps.com/sg

Poland

Georg Fischer Sp. z o.o.
05-090 Sekocin Nowy
Phone +48 (0) 22 31 31 0 50
poland.ps@georgfischer.com
www.gfps.com/pl

Romania

Georg Fischer Piping Systems (Switzerland) Ltd
020257 Bucharest - Sector 2
Phone +40 (0) 21 230 53 80
ro.ps@georgfischer.com
www.gfps.com/int

Russia

Georg Fischer Piping Systems (Switzerland) Ltd
Moscow 125040
Phone +7 495 748 11 44
ru.ps@georgfischer.com
www.gfps.com/ru

Singapore

Georg Fischer Pte Ltd
528 872 Singapore
Phone +65 6747 0611
Fax +65 6747 0577
sgp.ps@georgfischer.com
www.gfps.com/sg

Spain / Portugal

Georg Fischer S.A.
28046 Madrid / Spain
Phone +34 (0) 91 781 98 90
es.ps@georgfischer.com
www.gfps.com/es

Sweden

Georg Fischer AB
117 43 Stockholm
Phone +46 (0) 8 506 775 00
info.se.ps@georgfischer.com
www.gfps.com/se

Switzerland

Georg Fischer Rohrleitungssysteme (Schweiz) AG
8201 Schaffhausen
Phone +41 (0) 52 631 3026
ch.ps@georgfischer.com
www.gfps.com/ch

Taiwan

Georg Fischer Co. Ltd
San Chung Dist., New Taipei City
Phone +886 2 8512 2822
Fax +886 2 8512 2823
www.gfps.com/tw

United Kingdom / Ireland

George Fischer Sales Limited
Coventry, CV2 2ST / United Kingdom
Phone +44 (0) 2476 535 535
uk.ps@georgfischer.com
www.gfps.com/uk

USA / Caribbean

Georg Fischer LLC
92618 Irvine, CA / USA
Phone +1 714 731 8800
Fax +1 714 731 6201
us.ps@georgfischer.com
www.gfps.com/us

Vietnam

Georg Fischer Pte Ltd
Representative Office
Ho Chi Minh City
Phone +84 28 3948 4000
Fax +84 28 3948 4010
sgp.ps@georgfischer.com
www.gfps.com/vn

International

Georg Fischer Piping Systems (Switzerland) Ltd
8201 Schaffhausen / Switzerland
Phone +41 (0) 52 631 3003
Fax +41 (0) 52 631 2893
info.export@georgfischer.com
www.gfps.com/int

The information and technical data (altogether "Data") herein are not binding, unless explicitly confirmed in writing. The Data neither constitutes any expressed, implied or warranted characteristics, nor guaranteed properties or a guaranteed durability. All Data is subject to modification. The General Terms and Conditions of Sale of Georg Fischer Piping Systems apply.