

# Operating Instructions

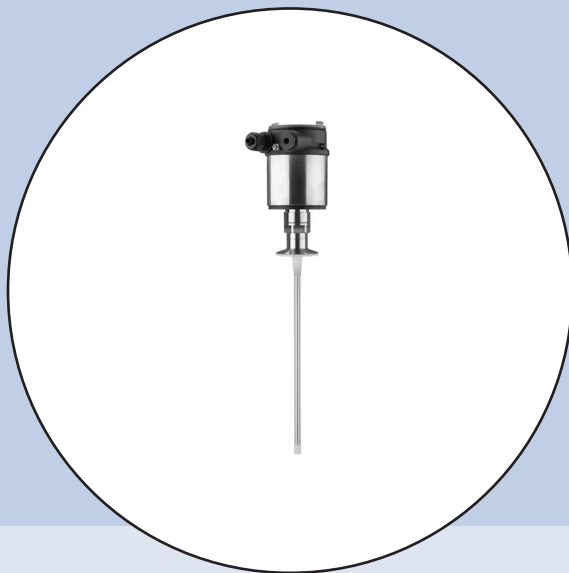

**LEVEL TRANSMITTER  
8189**

4 ... 20 mA/HART two-wire  
PFA coated rod and cable probe

# Contents

MAN 1000244883 EN Version: - Status: RL (released   freigegeben) printed: 22.09.2017	<b>1 About this document</b>		
	1.1	Function .....	4
	1.2	Target group .....	4
	1.3	Symbols used.....	4
	<b>2 For your safety</b>		
	2.1	Authorised personnel .....	5
	2.2	Appropriate use.....	5
	2.3	Warning about incorrect use.....	5
	2.4	General safety instructions .....	5
	2.5	CE conformity.....	5
	2.6	NAMUR recommendations .....	6
	<b>3 Product description</b>		
	3.1	Configuration.....	7
	3.2	Principle of operation.....	8
	3.3	Packaging, transport and storage.....	10
3.4	Accessories and replacement parts .....	10	
<b>4 Mounting</b>			
4.1	General instructions .....	12	
4.2	Mounting instructions .....	12	
<b>5 Connecting to power supply</b>			
5.1	Preparing the connection .....	18	
5.2	Connecting.....	19	
5.3	Wiring plan, single chamber housing.....	20	
5.4	Switch-on phase.....	20	
<b>6 Set up with the display and adjustment module</b>			
6.1	Insert display and adjustment module .....	22	
6.2	Adjustment system .....	23	
6.3	Parameter adjustment - Quick setup .....	24	
6.4	Parameter adjustment - Extended adjustment.....	26	
6.5	Saving the parameter adjustment data.....	45	
<b>7 Setup with PACTware</b>			
7.1	Connect the PC.....	47	
7.2	Parameter adjustment with PACTware.....	47	
7.3	Set up with the quick setup.....	48	
7.4	Saving the parameter adjustment data.....	53	
<b>8 Set up with other systems</b>			
8.1	DD adjustment programs .....	54	
8.2	Field Communicator 375, 475 .....	54	
<b>9 Diagnostics and service</b>			
9.1	Maintenance .....	55	
9.2	Diagnosis memory .....	55	
9.3	Status messages.....	56	
9.4	Rectify faults.....	60	
9.5	Exchanging the electronics module.....	62	
9.6	Software update .....	63	

9.7 How to proceed if a repair is needed ..... 63

**10 Dismounting**

10.1 Dismounting steps ..... 64  
 10.2 Disposal ..... 64

**11 Supplement**

11.1 Technical data ..... 65  
 11.2 Dimensions ..... 73

MAN 1000244883 EN Version: - Status: RL (released | freigegeben) printed: 22.09.2016



**Safety instructions for Ex areas**

Please note the Ex-specific safety information for installation and operation in Ex areas. These safety instructions are part of the operating instructions manual and come with the Ex-approved instruments.

Editing status: 2014-03-31

# 1 About this document

## 1.1 Function

This operating instructions manual provides all the information you need for mounting, connection and setup as well as important instructions for maintenance and fault rectification. Please read this information before putting the instrument into operation and keep this manual accessible in the immediate vicinity of the device.

## 1.2 Target group

This operating instructions manual is directed to trained specialist personnel. The contents of this manual should be made available to these personnel and put into practice by them.

## 1.3 Symbols used



### Information, tip, note

This symbol indicates helpful additional information.



**Caution:** If this warning is ignored, faults or malfunctions can result.



**Warning:** If this warning is ignored, injury to persons and/or serious damage to the instrument can result.



**Danger:** If this warning is ignored, serious injury to persons and/or destruction of the instrument can result.



### Ex applications

This symbol indicates special instructions for Ex applications.



### List

The dot set in front indicates a list with no implied sequence.



### Action

This arrow indicates a single action.



### Sequence of actions

Numbers set in front indicate successive steps in a procedure.



### Battery disposal

This symbol indicates special information about the disposal of batteries and accumulators.

## 2 For your safety

### 2.1 Authorised personnel

All operations described in this operating instructions manual must be carried out only by trained specialist personnel authorised by the plant operator.

During work on and with the device the required personal protective equipment must always be worn.

### 2.2 Appropriate use

LEVEL TRANSMITTER 8189 is a sensor for continuous level measurement.

You can find detailed information about the area of application in chapter "*Product description*".

Operational reliability is ensured only if the instrument is properly used according to the specifications in the operating instructions manual as well as possible supplementary instructions.

### 2.3 Warning about incorrect use

Inappropriate or incorrect use of the instrument can give rise to application-specific hazards, e.g. vessel overflow or damage to system components through incorrect mounting or adjustment.

### 2.4 General safety instructions

This is a state-of-the-art instrument complying with all prevailing regulations and guidelines. The instrument must only be operated in a technically flawless and reliable condition. The operator is responsible for the trouble-free operation of the instrument.

During the entire duration of use, the user is obliged to determine the compliance of the necessary occupational safety measures with the current valid rules and regulations and also take note of new regulations.

The safety instructions in this operating instructions manual, the national installation standards as well as the valid safety regulations and accident prevention rules must be observed by the user.

For safety and warranty reasons, any invasive work on the device beyond that described in the operating instructions manual may be carried out only by personnel authorised by the manufacturer. Arbitrary conversions or modifications are explicitly forbidden.

The safety approval markings and safety tips on the device must also be observed.

### 2.5 CE conformity

The device fulfills the legal requirements of the applicable EC guidelines. By affixing the CE marking, we confirm successful testing of the product.

**Electromagnetic compatibility**

Instruments in four-wire or Ex-d-ia version are designed for use in an industrial environment. Nevertheless, electromagnetic interference from electrical conductors and radiated emissions must be taken into account, as is usual with class A instruments according to EN 61326-1. If the instrument is used in a different environment, the electromagnetic compatibility to other instruments must be ensured by suitable measures.

**2.6 NAMUR recommendations**

NAMUR is the automation technology user association in the process industry in Germany. The published NAMUR recommendations are accepted as the standard in field instrumentation.

The device fulfills the requirements of the following NAMUR recommendations:

- NE 21 – Electromagnetic compatibility of equipment
- NE 43 – Signal level for malfunction information from measuring transducers
- NE 53 – Compatibility of field devices and display/adjustment components
- NE 107 – Self-monitoring and diagnosis of field devices

For further information see [www.namur.de](http://www.namur.de).

### 3 Product description

#### 3.1 Configuration

The type label contains the most important data for identification and use of the instrument:

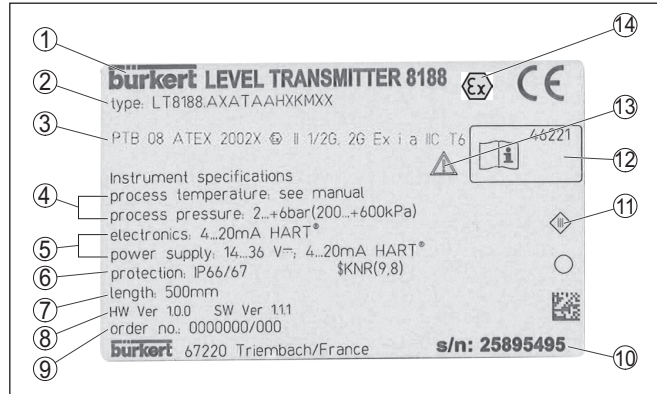

Fig. 1: Layout of the type label (example)

- 1 Instrument type
- 2 Product code
- 3 Approvals
- 4 Process and ambient temperature, process pressure
- 5 Power supply and signal output, electronics
- 6 Protection rating
- 7 Probe length
- 8 Hardware and software version
- 9 Order number
- 10 Serial number of the instrument
- 11 Symbol of the device protection class
- 12 ID numbers, instrument documentation
- 13 Reminder to observe the instrument documentation
- 14 Approval directives

#### Scope of this operating instructions manual

This operating instructions manual applies to the following instrument versions:

- Hardware from 1.0.0
- Software from 1.0.0
- Only for instrument versions without SIL qualification

#### Versions

The instrument and the electronics version can be determined via the product code on the type label as well as on the electronics.

- Standard electronics: Type FX80H.-

#### Scope of delivery

The scope of delivery encompasses:

- Sensor
- Documentation
  - this operating instructions manual

- Operating instructions manual "Display and adjustment module" (optional)
- Ex-specific "Safety instructions" (with Ex versions)
- if necessary, further certificates

### 3.2 Principle of operation

The LEVEL TRANSMITTER 8189 is a level sensor with coated cable or rod probe for continuous level or interface measurement, particularly suitable for applications in the chemical industry.

High frequency microwave pulses are guided along a steel cable or a rod. Upon reaching the product surface, the microwave pulses are reflected. The running time is evaluated by the instrument and outputted as level.

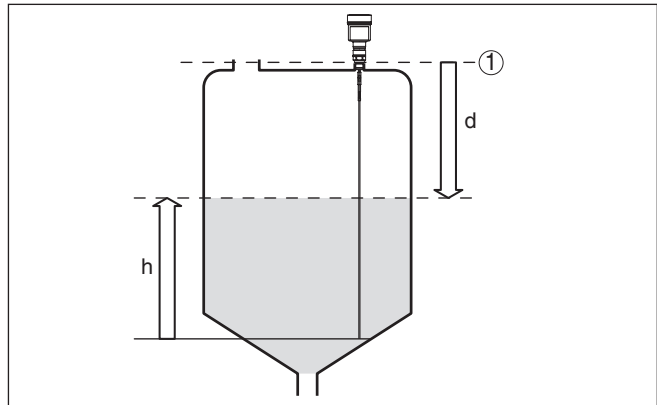

Fig. 2: Level measurement

- 1 Sensor reference plane (seal surface of the process fitting)
- d Distance to the interface (HART value 1)
- h Height - Level

#### Probe end tracking

To increase sensitivity, the probe is equipped with probe end tracking. In products with a low dielectric constant, this function is very helpful. This is the case, for example, in plastic granules, packing chips or in vessels with fluidized products.

Between a dielectric constant of 1.5 and 3, the function switches on, if required. As soon as the level echo can no longer be detected, probe end tracking is automatically activated. The measurement is continued with the last calculated dielectric constant.

The accuracy thus depends on the stability of the dielectric constant.

If you measure a medium with a dielectric constant below 1.5, probe end tracking is always active. In this case, you have to enter the dielectric constant of the medium. A stable dielectric constant is very important here.



**Functional principle - interface measurement**

High frequency microwave impulses are guided along a steel cable or rod. Upon reaching the product surface, a part of the microwave impulses is reflected. The other part passes through the upper product and is reflected by the interface. The running times to the two product layers are processed by the instrument.

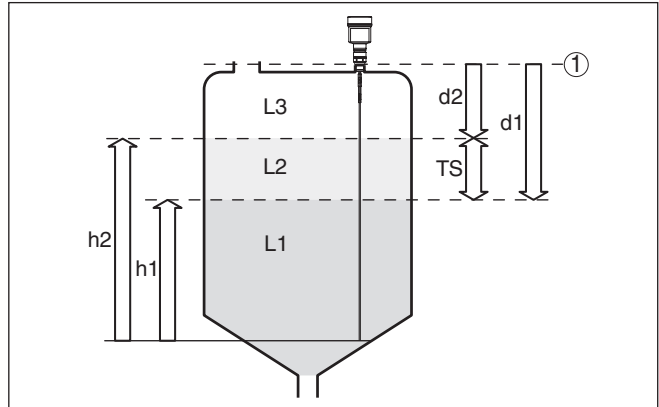

Fig. 3: Interface measurement

- 1 Sensor reference plane (seal surface of the process fitting)
- d1 Distance to the interface (HART value 1)
- d2 Distance to the level (HART value 3)
- TS Thickness of the upper medium (d1 - d2)
- h1 Height - Interface
- h2 Height - Level
- L1 Lower medium
- L2 Upper medium
- L3 Gas phase

**Prerequisites for interface measurement**

**Upper medium (L2)**

- The upper medium must not be conductive
- The dielectric constant of the upper medium or the actual distance to the interface must be known (input required). Min. dielectric constant: 1.6.
- The composition of the upper medium must be stable, no varying products or mixtures
- The upper medium must be homogeneous, no stratifications within the medium
- Min. thickness of the upper medium 50 mm (1.97 in)
- Clear separation from the lower medium, emulsion phase or detritus layer max. 50 mm (1.97 in)
- If possible, no foam on the surface

**Lower medium (L1)**

- The dielectric constant must be 10 higher than the dielectric constant of the upper medium, preferably electrically conductive. Example: upper medium dielectric constant 2, lower medium at least dielectric constant 12.

## Output signal

### Gas phase (L3)

- Air or gas mixture
- Gas phase - dependent on the application, gas phase does not always exist ( $d_2 = 0$ )

The instrument is always preset to the application "*Level measurement*".

For the interface measurement, you can select the requested output signal with the setup.

## Packaging

### 3.3 Packaging, transport and storage

Your instrument was protected by packaging during transport. Its capacity to handle normal loads during transport is assured by a test based on ISO 4180.

The packaging of standard instruments consists of environment-friendly, recyclable cardboard. For special versions, PE foam or PE foil is also used. Dispose of the packaging material via specialised recycling companies.

## Transport

Transport must be carried out in due consideration of the notes on the transport packaging. Nonobservance of these instructions can cause damage to the device.

## Transport inspection

The delivery must be checked for completeness and possible transit damage immediately at receipt. Ascertained transit damage or concealed defects must be appropriately dealt with.

## Storage

Up to the time of installation, the packages must be left closed and stored according to the orientation and storage markings on the outside.

Unless otherwise indicated, the packages must be stored only under the following conditions:

- Not in the open
- Dry and dust free
- Not exposed to corrosive media
- Protected against solar radiation
- Avoiding mechanical shock and vibration
- Storage and transport temperature see chapter "*Supplement - Technical data - Ambient conditions*"
- Relative humidity 20 ... 85 %

## Storage and transport temperature

### 3.4 Accessories and replacement parts

## Display and adjustment module

The display and adjustment module is used for measured value indication, adjustment and diagnosis. It can be inserted into the sensor and removed at any time.

You can find further information in the operating instructions "*Display and adjustment module*" (Document-ID 41787).

## Flanges

Screwed flanges are available in different versions according to the following standards: DIN 2501, EN 1092-1, BS 10, ANSI B 16.5, JIS B 2210-1984, GOST 12821-80.

You can find additional information in the supplementary instructions manual "*Flanges according to DIN-EN-ASME-JIS*" (Document-ID 33784).

## Electronics module

The electronics module is a replacement part of the TDR sensors. A version is available for each type of signal output.

You can find further information in the operating instructions manual "*Electronics module LEVEL TRANSMITTER 818X*".

## Spacer

If you mount the LEVEL TRANSMITTER 8189 in a bypass tube or standpipe, you have to avoid contact to the bypass tube by using a spacer at the probe end.

You can find additional information in the operating instructions manual "*Centering*".

## 4 Mounting

### 4.1 General instructions

Protect your instrument against moisture penetration through the following measures:

- Use the recommended cable (see chapter "*Connecting to power supply*")
- Tighten the cable gland
- Turn the housing in such a way that the cable gland points downward
- Loop the connection cable downward in front of the cable gland

This applies particularly to:

- Outdoor mounting
- Installations in areas where high humidity is expected (e.g. through cleaning processes)
- Installations on cooled or heated vessels

In the case of instrument housings with self-sealing NPT threads, it is not possible to have the cable entries screwed in at the factory. The openings for the cable glands are therefore covered with red protective caps as transport protection.

Prior to setup you have to replace these protective caps with approved cable glands or close the openings with suitable blind plugs.

The suitable cable glands and blind plugs come with the instrument.

Make sure that all parts of the instrument exposed to the process are suitable for the existing process conditions.

These are mainly:

- Active measuring component
- Process fitting
- Process seal

Process conditions are particularly:

- Process pressure
- Process temperature
- Chemical properties of the medium
- Abrasion and mechanical influences

You can find the specifications of the process conditions in chapter "*Technical data*" as well as on the type label.

### 4.2 Mounting instructions

Mount LEVEL TRANSMITTER 8189 in such a way that the distance to vessel installations or to the vessel wall is at least 300 mm (12 in). In non-metallic vessels, the distance to the vessel wall should be at least 500 mm (19.7 in).

During operation, the probe must not touch any installations or the vessel wall. If necessary, fasten the probe end.

Protection against moisture

Protective caps

Stability for the process conditions

Installation position

MAN 100024483 EN Version: - Status: RL (released | freigegeben) printed: 2017

46272-EN-140605

**Tip of vessel**

In vessels with conical bottom it can be advantageous to mount the sensor in the center of the vessel, as measurement is then possible nearly down to the lowest point of the bottom. Keep in mind that measurement all the way down to the tip of the probe may not be possible. The exact value of the min. distance (lower dead band) is stated in chapter "Technical data".

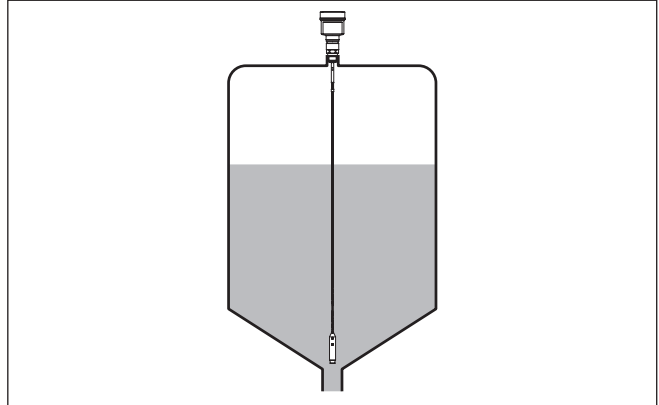

Fig. 4: Vessel with conical bottom

**Plastic vessel/Glass vessel**

The guided microwave principle requires a metallic surface on the process fitting. Therefore, in plastic vessels, etc., use an instrument version with flange (from DN 50) or place a metal sheet ( $\varnothing > 200 \text{ mm}/8 \text{ in}$ ) beneath the process fitting when screwing it in.

Make sure that the plate has direct contact with the process fitting.

When installing rod or cable probes in vessels without metal walls, e.g. in plastic vessels, the measured value can be influenced by strong electromagnetic fields (emitted interference according to EN 61326: class A). In this case, use a probe with coaxial version.

**Socket**

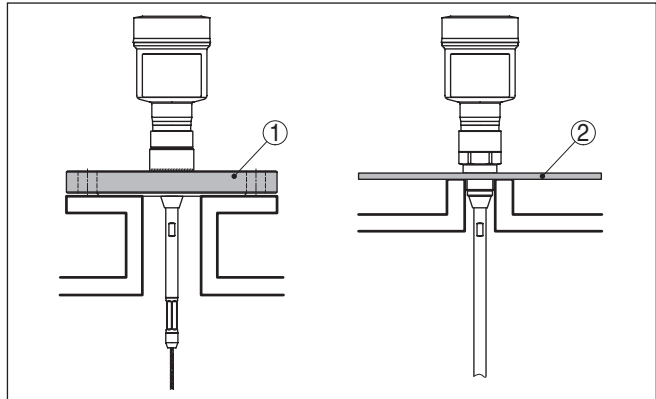

Fig. 5: Installation in non-metallic vessel

- 1 Flange
- 2 Metal sheet

If possible, avoid sockets. Mount the sensor flush with the vessel top. If this is not possible, use short sockets with small diameter.

Higher sockets or sockets with a bigger diameter can generally be used. They can, however, increase the upper blocking distance (dead band). Check if this is relevant for your measurement.

In such cases, always carry out a false signal suppression after installation. You can find further information under "Setup procedure".

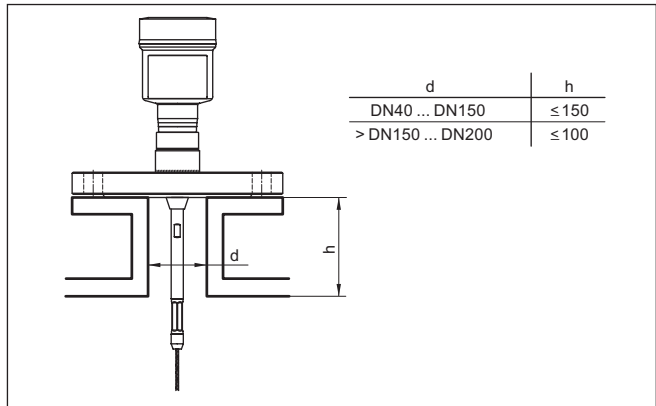

Fig. 6: Mounting socket

When welding the socket, make sure that the socket is flush with the vessel top.

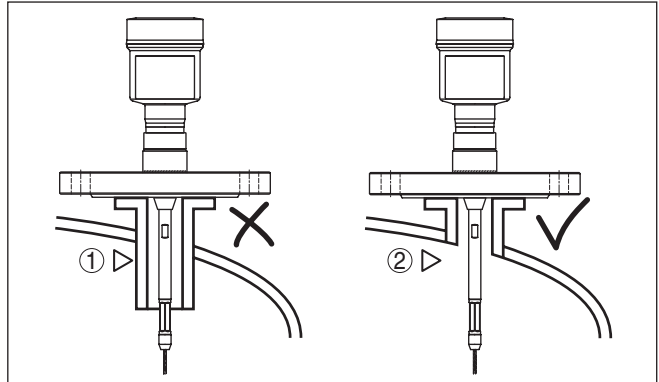

Fig. 7: Socket must be installed flush

- 1 Unfavourable installation
- 2 Socket flush - optimum installation

**Welding work**

Before beginning the welding work, remove the electronics module from the sensor. By doing this, you avoid damage to the electronics through inductive coupling.

**Inflowing medium**

Do not mount the instruments in or above the filling stream. Make sure that you detect the product surface, not the inflowing product.

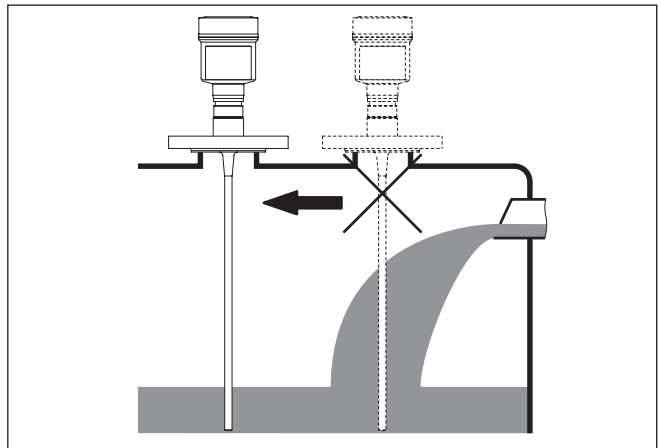

Fig. 8: Mounting of the sensor with inflowing medium

**Measuring range**

The reference plane for the measuring range of the sensors is the sealing surface of the thread or flange.

Keep in mind that a min. distance must be maintained below the reference plane and possibly also at the end of the probe - measurement in these areas is not possible (dead band). The length of the cable can be used all the way to the end only when measuring conductive

## Pressure

products. These blocking distances for different mediums are listed in chapter "*Technical data*". Keep in mind for the adjustment that the default setting for the measuring range refers to water.

The process fitting must be sealed if there is gauge or low pressure in the vessel. Before use, check if the seal material is resistant against the measured product and the process temperature.

The max. permissible pressure is specified in chapter "*Technical data*" or on the type label of the sensor.

## Lateral installation

In case of difficult installation conditions, the probe can be also mounted laterally. For this purpose, adapt the rod with rod extensions or bow-shaped segments.

Let the probe length determine automatically by the instrument to compensate the resulting running time changes.

The determine probe length can deviate from the actual probe length when using bow-shaped segments.

If installations such as struts, ladders, etc. exist on the vessel wall, then the probe should have a distance to the vessel wall of at least 300 mm (11.81 in).

You can find further information in the supplementary instructions of the rod extension.

## Rod extension

In case of difficult installation conditions, for example in a socket, the probe can be adapted respectively with a rod extension.

Let the probe length determine automatically by the instrument to compensate the resulting running time changes.

You can find further information in the supplementary instructions of the rod extension.

## Torque with PTFE plated flanges

The PTFE washer of the antenna encapsulation serves also as process seal.

To compensate the normal prestress loss due to the seal materials, you have to use also disc springs in addition to the flange screws for fastening PTFE plated flanges.

We recommend flexible retaining washers (e.g. Schnorr VS or S) or detent edged rings (e.g. Gross VS KD).

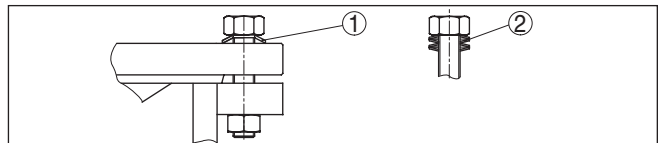

Fig. 9: Use of disc springs

- 1 Single disc spring
- 2 Laminated disc spring

The flange screws of LEVEL TRANSMITTER 8189 must be tightened with a torque of approx. 60 Nm (44 lbf ft) so that the PTFE washer seals reliably.



MAN 1000244883 EN Version: - Status: RL (released | freigegeben) printed: 22.09.2017

**Note:**

We recommend, retightening the screws in regular intervals depending on process pressure and temperature

## 5 Connecting to power supply

### 5.1 Preparing the connection

Always keep in mind the following safety instructions:

- Connect only in the complete absence of line voltage
- If overvoltage surges are expected, overvoltage arresters should be installed

Power supply and current signal are carried on the same two-wire cable. The operating voltage can differ depending on the instrument version.

The data for power supply are specified in chapter "*Technical data*".

Provide a reliable separation between the supply circuit and the mains circuits according to DIN EN 61140 VDE 0140-1.

Keep in mind the following additional factors that influence the operating voltage:

- Lower output voltage of the power supply unit under nominal load (e.g. with a sensor current of 20.5 mA or 22 mA in case of fault)
- Influence of additional instruments in the circuit (see load values in chapter "*Technical data*")

The instrument is connected with standard two-wire cable without screen. If electromagnetic interference is expected which is above the test values of EN 61326-1 for industrial areas, screened cable should be used.

We generally recommend the use of screened cable for HART multi-drop mode.

Use cable with round cross section for instruments with housing and cable gland. To ensure the seal effect of the cable gland (IP protection rating), find out which cable outer diameter the cable gland is suitable for.

Use a cable gland fitting the cable diameter.

#### Cable gland ½ NPT

With plastic housing, the NPT cable gland or the Conduit steel tube must be screwed without grease into the threaded insert.

Max. torque for all housings see chapter "*Technical data*".

#### Cable screening and grounding

If screened cable is required, we recommend connecting the cable screen on both ends to ground potential. In the sensor, the screen must be connected directly to the internal ground terminal. The ground terminal on the outside of the housing must be connected to the ground potential (low impedance).



With Ex systems, the grounding is carried out according to the installation regulations.

In electroplating and CCP systems (cathodic corrosion protection) it must be taken into account that significant potential differences exist. This can lead to unacceptably high shield currents if the cable shield is grounded at both ends.

Safety instructions

Voltage supply

Connection cable

Cable gland ½ NPT

Cable screening and grounding

MAN 1000244883 EN Version: - Status: RL (released | freigegeben) printed: 22.09.2017

46272-EN-140605



**Information:**

The metallic parts of the instrument (process fitting, transmitter, concentric tube, etc.) are conductively connected with the inner and outer ground terminal on the housing. This connection exists either directly via connecting metallic parts or, in case of instruments with external electronics, via the screen of the special connection cable.

You can find specifications on the potential connections inside the instrument in chapter "Technical data".

**5.2 Connecting**

The voltage supply and signal output are connected via the spring-loaded terminals in the housing.

Connection to the display and adjustment module or to the interface adapter is carried out via contact pins in the housing.



**Information:**

The terminal block is pluggable and can be removed from the electronics. To do this, lift the terminal block with a small screwdriver and pull it out. When reinserting the terminal block, you should hear it snap in.

Proceed as follows:

1. Unscrew the housing cover
2. If a display and adjustment module is installed, remove it by turning it slightly to the left.
3. Loosen compression nut of the cable entry gland
4. Remove approx. 10 cm (4 in) of the cable mantle, strip approx. 1 cm (0.4 in) of insulation from the ends of the individual wires
5. Insert the cable into the sensor through the cable entry

**Connection procedure**



Fig. 10: Connection steps 5 and 6 - Single chamber housing

6. Insert the wire ends into the terminals according to the wiring plan



### Information:

Solid cores as well as flexible cores with wire end sleeves are inserted directly into the terminal openings. In case of flexible cores without end sleeves, press the terminal from above with a small screwdriver, the terminal opening is then free. When the screwdriver is released, the terminal closes again.

You can find further information on the max. wire cross-section under "*Technical data/Electromechanical data*"

7. Check the hold of the wires in the terminals by lightly pulling on them
8. Connect the screen to the internal ground terminal, connect the outer ground terminal to potential equalisation
9. Tighten the compression nut of the cable entry gland. The seal ring must completely encircle the cable
10. Reinsert the display and adjustment module, if one was installed
11. Screw the housing cover back on

The electrical connection is finished.

### 5.3 Wiring plan, single chamber housing



The following illustration applies to the non-Ex, Ex-ia and Ex-d version.

#### Electronics and terminal compartment

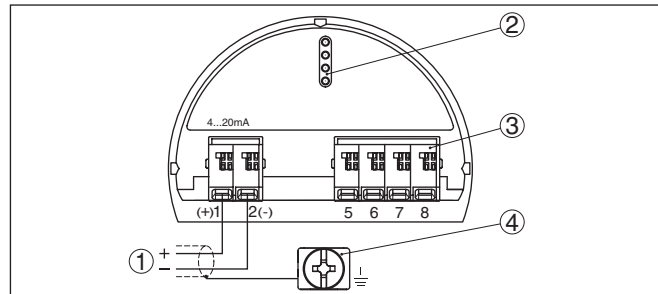

Fig. 11: Electronics and terminal compartment, single chamber housing

- 1 Voltage supply, signal output
- 2 For display and adjustment module or interface adapter
- 3 For external display and adjustment unit
- 4 Ground terminal for connection of the cable screen

### 5.4 Switch-on phase

After connecting the instrument to power supply or after a voltage recurrence, the instrument carries out a self-check for approx. 30 s:

- Internal check of the electronics
- Indication of the instrument type, hardware and software version, measurement loop name on the display or PC
- Indication of the status message "F 105 Determine measured value" on the display or PC
- The output signal jumps to the set fault current

As soon as a plausible measured value is found, the corresponding current is outputted to the signal cable. The value corresponds to the actual level as well as the settings already carried out, e.g. factory setting.

MAN 1000244883 EN Version: - Status: RL (released | freigegeben) printed: 22.09.2017

## 6 Set up with the display and adjustment module

### 6.1 Insert display and adjustment module

The display and adjustment module can be inserted into the sensor and removed again at any time. You can choose any one of four different positions - each displaced by 90°. It is not necessary to interrupt the power supply.

Proceed as follows:

1. Unscrew the housing cover
2. Place the display and adjustment module in the requested position onto the electronics and turn to the right until it snaps in
3. Screw housing cover with inspection window tightly back on

Removal is carried out in reverse order.

The display and adjustment module is powered by the sensor, an additional connection is not necessary.

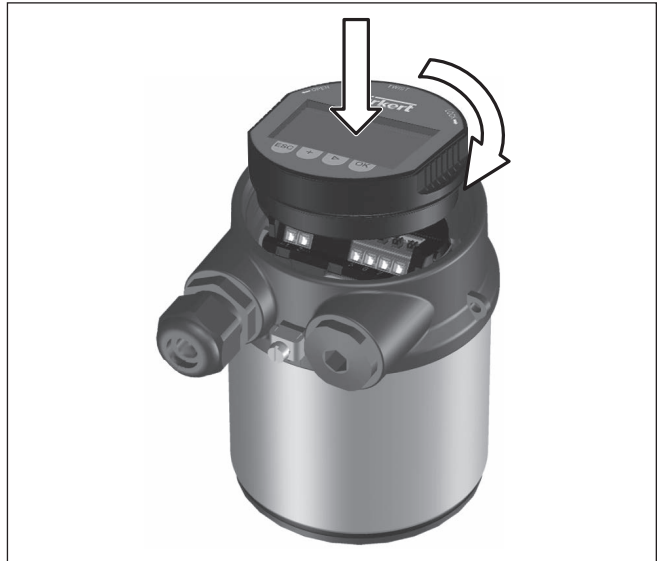

Fig. 12: Insertion of the display and adjustment module with single chamber housing



#### Note:

If you intend to retrofit the instrument with a display and adjustment module for continuous measured value indication, a higher cover with an inspection glass is required.

## 6.2 Adjustment system

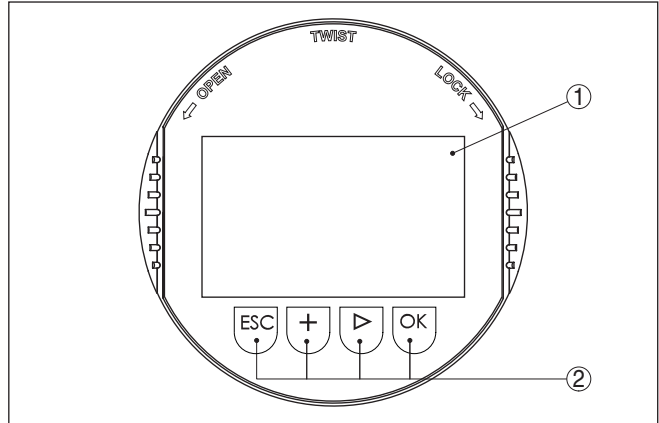

Fig. 13: Display and adjustment elements

- 1 LC display
- 2 Adjustment keys

### Key functions

- **[OK]** key:
  - Move to the menu overview
  - Confirm selected menu
  - Edit parameter
  - Save value
- **[->]** key:
  - Presentation, change measured value
  - Select list entry
  - Select editing position
- **[+]** key:
  - Change value of the parameter
- **[ESC]** key:
  - Interrupt input
  - Jump to next higher menu

### Adjustment system

The sensor is adjusted via the four keys of the display and adjustment module. The LC display indicates the individual menu items. The functions of the individual keys are shown in the above illustration. Approx. 10 minutes after the last pressing of a key, an automatic reset to measured value indication is triggered. Any values not confirmed with **[OK]** will not be saved.

### Switch-on phase

After switching on, the LEVEL TRANSMITTER 8189 carries out a short self-test where the device software is checked.

The output signal transmits a fault signal during the switch-on phase.

The following information is displayed on the display and adjustment module during the startup procedure:

- Instrument type

- Device name
- Software version (SW-Ver)
- Hardware version (HW-Ver)

## Measured value indication

With the **[->]** key you can move between three different indication modes.

In the first view, the selected measured value is displayed in large digits.

In the second view, the selected measured value and a corresponding bar graph presentation are displayed.

In the third view, the selected measured value as well as a second selectable value, e.g. the temperature, are displayed.



## Quick setup

### 6.3 Parameter adjustment - Quick setup

To quickly and easily adapt the sensor to the application, select the menu item "*Quick setup*" in the start graphic on the display and adjustment module.



You can find "Extended adjustment" in the next sub-chapter.

## General information

### Measurement loop name

In the first menu item you can assign a suitable measurement loop name. You can enter a name with max. 19 characters.

### Type of medium

In the next menu item you can see which type of medium the instrument is suitable for. If your instrument is only suitable for a certain medium, this menu item is not visible.

### Application

In this menu item, you can select the application. You can choose between level measurement and interface measurement. You can also choose between measurement in a vessel or in a bypass or standpipe.

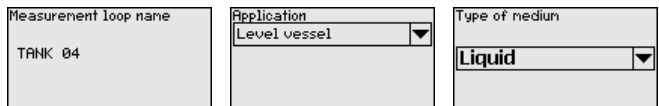

## Level measurement

### Medium - dielectric constant

In this menu item, you can define the type of medium (product).

### Max. adjustment

In this menu item, you can enter the max. adjustment for the level.



**Interface measurement**

Enter the appropriate distance value in m (corresponding to the percentage value) for the full vessel. The distance refers to the sensor reference plane (seal surface of the process fitting). Keep in mind that the max. level must lie below the dead band.

**Min. adjustment**

In this menu item, you can enter the min. adjustment for the level.

Enter the suitable distance value in m for the empty vessel (e.g. distance from the flange to the probe end) corresponding to the percentage value. The distance refers to the sensor reference plane (seal surface of the process fitting).

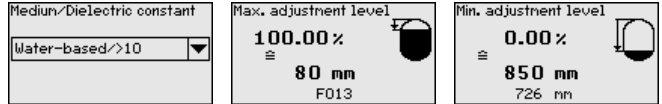

**Dielectric constant - upper medium**

In this menu item, you can define the type of medium (product).

**Max. adjustment**

In this menu item, you can enter the max. adjustment for the level.

Enter the appropriate distance value in m (corresponding to the percentage value) for the full vessel. The distance refers to the sensor reference plane (seal surface of the process fitting). Keep in mind that the max. level must lie below the dead band.

**Min. adjustment**

In this menu item, you can enter the min. adjustment for the level.

Enter the suitable distance value in m for the empty vessel (e.g. distance from the flange to the probe end) corresponding to the percentage value. The distance refers to the sensor reference plane (seal surface of the process fitting).



**Max. adjustment - Interface**

Carry out the max. adjustment for the interface.

To do this, enter the percentage value and the suitable distance value in m for the full vessel.

**Min. adjustment - Interface**

Carry out the min. adjustment for the interface.

To do this, enter the percentage value and the suitable distance value in m for the empty vessel.



## Linearization

MAN 1000244883 EN Version: - Status: RL (released | freigegeben) printed: 22.09.2017

### Linearization

A linearization is necessary for all vessels in which the vessel volume does not increase linearly with the level - e.g. a horizontal cylindrical or spherical tank, when the indication or output of the volume is required. Corresponding linearization curves are preprogrammed for these vessels. They represent the correlation between the level percentage and vessel volume.

The linearization applies for the measured value indication and the current output. By activating the suitable curve, the percentage vessel volume is displayed correctly.

### False signal suppression

High sockets and internal vessel installations cause interfering reflections and can influence the measurement.

A false signal suppression detects, marks and saves these false signals so that they are no longer taken into account for the level and interface measurement. We generally recommend carrying out a false signal suppression to achieve the best possible accuracy. This should be done with the lowest possible level so that all potential interfering reflections can be detected.

Enter the actual distance from the sensor to the product surface.

All interfering signals in this section are detected by the sensor and stored.

The instrument carries out an automatic false signal suppression as soon as the probe is uncovered. The false signal suppression is always updated.

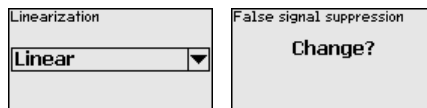

## 6.4 Parameter adjustment - Extended adjustment

For technically demanding measuring points, you can carry out extended settings in "Extended adjustment".

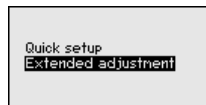

## Main menu

The main menu is divided into five sections with the following functions:

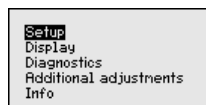

**Setup:** Settings, e.g. measurement loop name, medium, vessel, adjustment, signal output, device unit, false signal suppression, linearization curve

**Display:** Settings, e.g., for language, measured value display, lighting

**Diagnosis:** Information, e.g. on instrument status, pointer, measurement reliability, simulation, echo curve

**Additional adjustments:** Reset, date/time, reset, copy function

**Info:** Instrument name, hardware and software version, date of manufacture, instrument features



**Note:**

For optimum adjustment of the measuring point, the individual sub-menu items in the main menu item "Setup" should be selected one after the other and provided with the correct parameters. If possible, go through the items in the given sequence.

The procedure is described below.

The following submenu points are available:

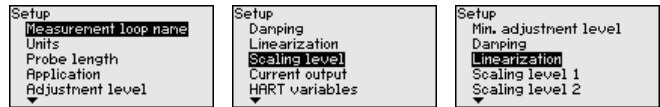

The submenu points described below.

**Setup - Measurement loop name**

Here you can assign a suitable measurement loop name. Push the "OK" key to start the processing. With the "+" key you change the sign and with the "->" key you jump to the next position.

You can enter names with max. 19 characters. The character set comprises:

- Capital letters from A ... Z
- Numbers from 0 ... 9
- Special characters + - / \_ blanks

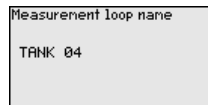

**Setup - Units**

In this menu item you select the distance unit and the temperature unit.

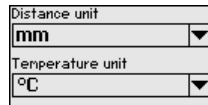

With the distance units you can choose between m, mm and ft and with the temperature units between °C, °F and K.

**Setup - Probe length**

In this menu item you can enter the probe length or have the length determined automatically by the sensor system.

When choosing "Yes", then the probe length will be determined automatically. When choosing "No", you can enter the probe length manually.

## Setup - Type of medium

Probe length
1000 mm

Probe length determine automatically?
Yes No

Probe length
01000
mm
0 80000

In this menu item you can select which type of medium you want to measure. You can choose between liquid or bulk solid.

Type of medium
Liquid

Type of medium
<input checked="" type="checkbox"/> Liquid <input type="checkbox"/> Solid

## Setup - Application

In this menu item, you can select the application. You can choose between level measurement and interface measurement. You can also choose between measurement in a vessel or in a bypass or standpipe.



### Note:

The selection of the application has a considerable influence on all other menu items. Keep in mind that as you continue with the parameter adjustment, individual menu items are only optionally available. You have the option of choosing the demonstration mode. This mode is only suitable for test and demonstration purposes. In this mode, the sensor ignores the parameters of the application and reacts immediately to each change.

You have to enter the tube inner diameter when measuring in a bypass or standpipe.

Application
Level vessel

Application
<input checked="" type="checkbox"/> Level vessel <input type="checkbox"/> Level bypass/standpipe <input type="checkbox"/> Interface vessel <input type="checkbox"/> Interf.bypass/standpipe <input type="checkbox"/> Demonstration mode

## Setup - Application - Medium, dielectric constant

In this menu item, you can define the type of medium (product).

This menu item is only available if you have selected level measurement under the menu item "Application".

Application
Product type
Application
Medium/Dielectric figure

Medium/Dielectric constant
Water-based >10

Medium/Dielectric constant
Solvents,oilLPG <3 Chem. mixtures/3...10
<input checked="" type="checkbox"/> Water-based >10

You can choose between the following medium types:

Dielectric constant	Type of medium	Examples
> 10	Water-based liquids	Acids, alcalis, water
3 ... 10	Chemical mixtures	Chlorobenzene, nitro lacquer, aniline, isocyanate, chloroform
< 3	Hydrocarbons	Solvents, oils, liquid gas

**Setup - Application - Gas phase**

This menu item is only available, if you have chosen interface measurement under the menu item "Application". In this menu item you can enter if there is a superimposed gas phase in your application.

Only set the function to "Yes", if the gas phase is permanently present.

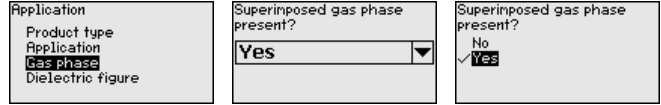

**Setup - Application - Dielectric constant**

This menu item is only available if you have selected interface measurement under the menu item "Application". In this menu item you can choose the type of medium of the upper medium.

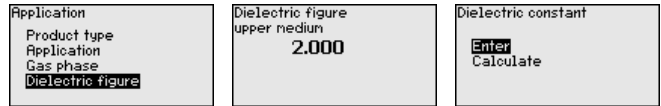

You can enter the dielectric constant of the upper medium directly or have the value determined by the instrument. To do this you have to enter the measured or known distance to the interface.

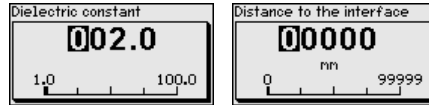

**Setup - Max. adjustment Level**

In this menu item you can enter the max. adjustment for the level. With interface measurement this is the maximum total level.

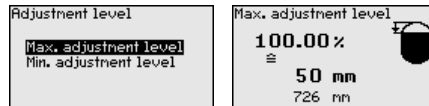

Adjust the requested percentage value with [+/-] and store with [OK].

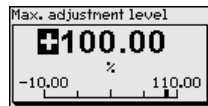

Enter the appropriate distance value in m (corresponding to the percentage value) for the full vessel. The distance refers to the sensor reference plane (seal surface of the process fitting). Keep in mind that the max. level must lie below the dead band.



**Setup - Min. adjustment Level**

In this menu item you can enter the min. adjustment for the level. With interface measurement this is the minimum total level.

MAN 1000244889 | Version: - Status: RL (released | freigegeben) | printed: 22.09.2017

MAN 1000244883 EN Version: - Stage: RL (released | freigegeben) printed: 22.09.2017

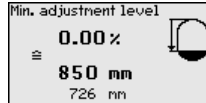
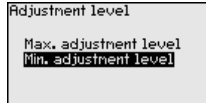

Adjust the requested percentage value with **[+]** and store with **[OK]**.

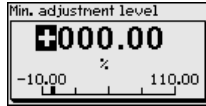

Enter the suitable distance value in m for the empty vessel (e.g. distance from the flange to the probe end) corresponding to the percentage value. The distance refers to the sensor reference plane (seal surface of the process fitting).

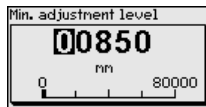

**Setup - Max. adjustment - Interface**

This menu item is only available if you have selected interface measurement under the menu item "Application".

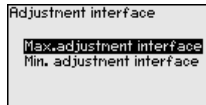

You can accept the adjustment of the level measurement also for the interface measurement. If you select "Yes", the current setting will be displayed.

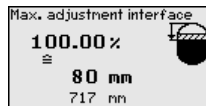
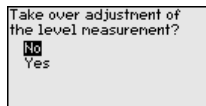

If you have selected "No", you can enter the adjustment for the interface separately. Enter the requested percentage value.

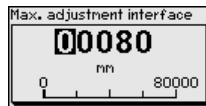
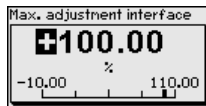

For the full vessel, enter the distance value in m matching the percentage value.

**Setup - Min. adjustment - Interface**

This menu item is only available if you have selected interface measurement under the menu item "Application". If you have selected "Yes" in the previous menu item (accept adjustment of the level measurement), the current setting will be displayed.

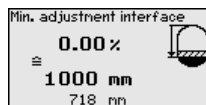
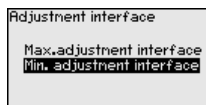

46272-EN-140605

If you have selected "No", you can enter the adjustment for the interface measurement separately.

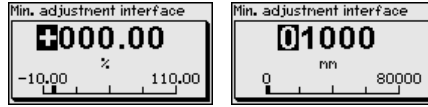

Enter the respective distance value in m for the empty vessel corresponding to the percentage value.

MAN 1000244883 EN Version: Status: RL (released | freigegeben) printed: 22.09.2017

**Setup - Damping**

To damp process-dependent measured value fluctuations, set an integration time of 0 ... 999 s in this menu item.

If you have selected interface measurement under the menu item "Application", you can adjust the damping for the level and the interface separately.

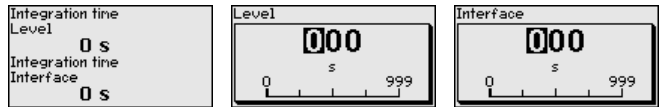

The default setting is a damping of 0 s.

**Setup - Linearization**

A linearization is necessary for all vessels in which the vessel volume does not increase linearly with the level - e.g. a horizontal cylindrical or spherical tank, when the indication or output of the volume is required. Corresponding linearization curves are preprogrammed for these vessels. They represent the correlation between the level percentage and vessel volume.

The linearization applies to the measured value indication and the current output. By activating the appropriate curve, the volume percentage of the vessel is displayed correctly. If the volume should not be displayed in percent but e.g. in l or kg, a scaling can be also set in the menu item "Display".

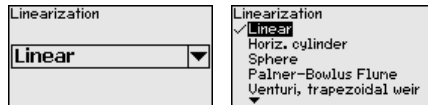

**Warning:**

If a linearization curve is selected, the measuring signal is no longer necessarily linear to the filling height. This must be considered by the user especially when adjusting the switching point on the limit signal transmitter.

In the following, you have to enter the values for your vessel, for example the vessel height and the socket correction.

For non-linear vessel forms, enter the vessel height und the socket correction.

For the vessel height, you have to enter the total height of the vessel.

For the socket correction you have to enter the height of the socket above the upper edge of the vessel. If the socket is lower than the upper edge of the vessel, this value can also be negative.

MAN 1000244883 EN Version: - Status: RL (released | freigegeben) printed: 22.09.2017

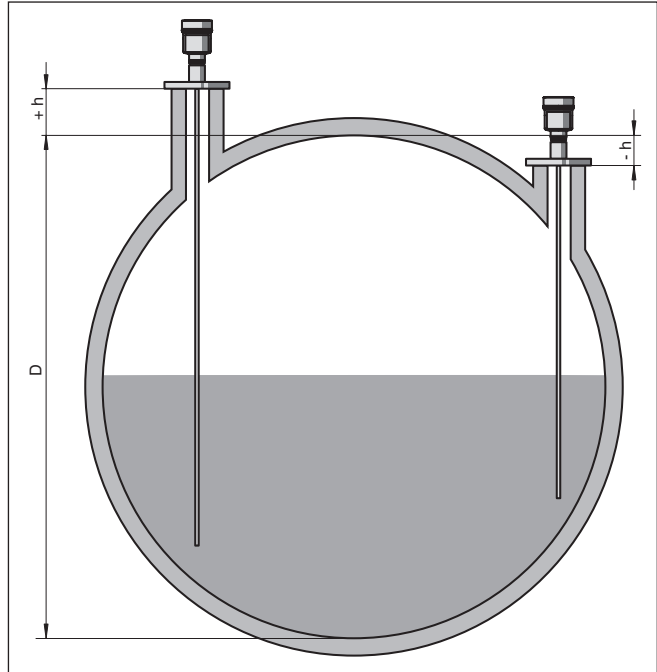
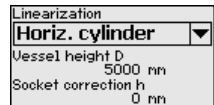
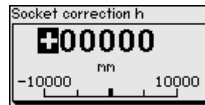
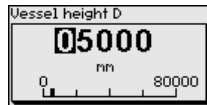

Fig. 14: Vessel height und socket correction value

*D* Vessel height

*+h* Positive socket correction value

*-h* Negative socket correction value



### Setup - Scaling Level

Since scaling is very extensive, scaling of the level value was divided into two menu items.

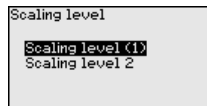

### Setup - Scaling Level 1

In menu item "Level 1" you define the scaling variable and the scaling unit for the level value on the display, e.g. volume in l.

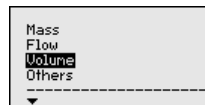
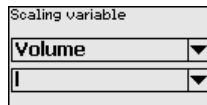

46272-EN-140605



**Setup - Scaling Level 2**

Since scaling is very extensive, scaling of the level value was divided into two menu items.

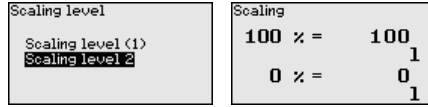

In menu item "Level 2" you define the scaling format on the display and the scaling of the measured level value for 0 % and 100 %.

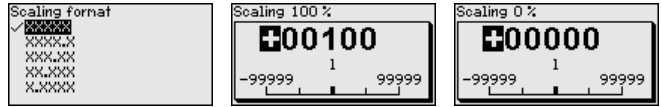

**Setup - Scaling Interface**

Since scaling is very extensive, scaling of the interface value was divided into two menu items.

**Setup - Scaling Interface**

In menu item "Interface 1" you define the scaling size and the scaling unit for the interface value on the display, e.g. volume in l.

You can accept the scaling of the level measurement also for the interface measurement. If you select "Yes", the current setting is displayed.

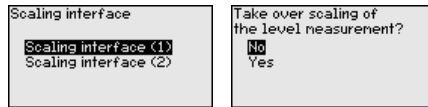

If you have selected "No", you can enter the scaling for the interface separately.

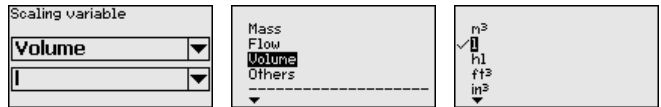

**Setup - Scaling Interface**

In menu item "Interface (2)" you define the scaling format on the display and the scaling of the interface measured value for 0 % and 100 %.

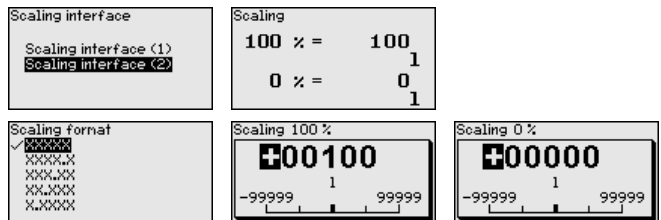

**Setup - Current output Size**

In menu item "Current output, size" you determine which measured value the current output refers to.

Released (freigegeben) printed: 22.09.2017  
 Status: R1  
 Version: - Status: R1  
 EN Version: - Status: R1  
 MAN 1000244883 EN Version: - Status: R1  
 46272-EN-140605

Released | freigegeben | printed | gedruckt  
 MAN 00244883 EN Version: - Status: Release  
 02.09.2017

### Setup - Current output, adjustment

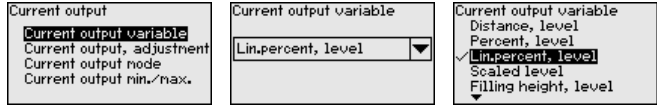

In menu item "*Current output, adjustment*" you can assign a respective measured value to the current output.

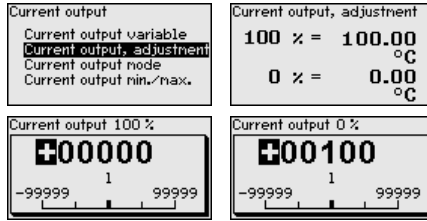

### Setup - Current output mode

In the menu item "*Current output mode*" you determine the output characteristics and reaction of the current output in case of failure.

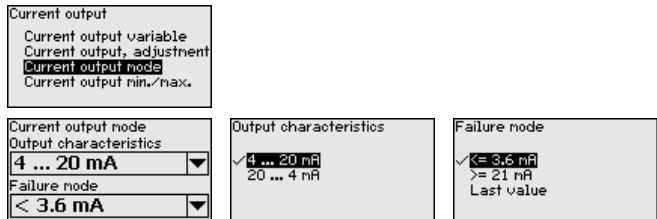

The default setting is output characteristics 4 ... 20 mA, failure mode < 3.6 mA.

### Setup - Current output Min./Max.

In the menu item "*Current output Min./Max.*", you determine the reaction of the current output during operation.

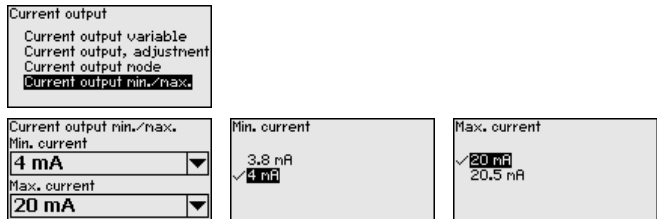

The default setting is min. current 3.8 mA and max. current 20.5 mA.

### Setup - Current output 2

If a supplementary electronics with an additional current output is implemented in the instrument, then you can adjust the additional current output separately.

In menu item "*Current output 2*" you specify which measured value the additional current output refers to.

The procedure corresponds to the previous settings of the standard current output. See "*Setup - Current output*".

46272-EN-140605

02.09.2017  
 Setup - HART variables  
 Setup - HART variables  
 Setup - False signal suppression  
 MAN

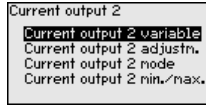

**Setup - HART variables**

Since the HART variables are very extensive, the indication was divided into two menu items.

In the menu "*HART variables 1*" you can have the first HART value PV (primary value) and the second HART value SV (secondary value) of the sensor displayed.

The values cannot be changed in the display and adjustment module. To change these values, you have to use the adjustment software PACTware.

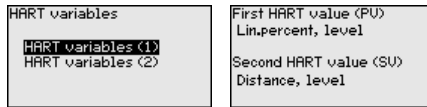

**Setup - HART variables**

In the menu "*HART variables 2*" you can have the third HART value TV (third value) and the fourth HART value QV (quarter value) of the sensor displayed.

The values cannot be changed in the display and adjustment module. To change these values, you have to use the adjustment software PACTware.

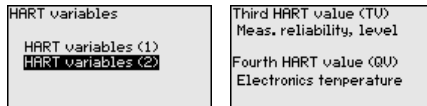

**Setup - False signal suppression**

The following circumstances cause interfering reflections and can influence the measurement:

- High sockets
- Vessel installations such as struts



**Note:**

A false signal suppression detects, marks and saves these false signals so that they are no longer taken into account for the level and interface measurement. We generally recommend carrying out a false signal suppression to achieve the best possible accuracy. This should be done with the lowest possible level so that all potential interfering reflections can be detected.

Proceed as follows:

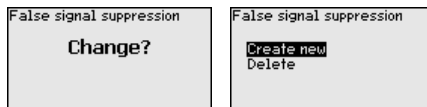

Enter the actual distance from the sensor to the product surface.

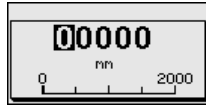

All interfering signals in this section are detected by the sensor and stored.



**Note:**

Check the distance to the product surface, because if an incorrect (too large) value is entered, the existing level will be saved as a false echo. The filling level would then no longer be detectable in this area.

If a false signal suppression has already been created in the sensor, the following menu window appears when selecting "*False signal suppression*":

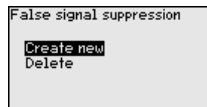

The instrument carries out an automatic false signal suppression as soon as the probe is uncovered. The false signal suppression is always updated.

The menu item "*Delete*" is used to completely delete an already created false signal suppression. This is useful if the saved false signal suppression no longer matches the metrological conditions in the vessel.

## Lock/release setup - Adjustment

In the menu item "*Lock/unlock adjustment*", you can protect the sensor parameters against unauthorized modification. The PIN is activated/deactivated permanently.

The following adjustment functions are possible without entering the PIN:

- Select menu items and show data
- Read data from the sensor into the display and adjustment module.

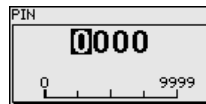

**Caution:**

With active PIN, adjustment via PACTware/DTM as well as other systems is also blocked.

You can change the PIN number under "*Additional adjustments - PIN*".

## Display

In the main menu point "*Display*", the individual submenu points should be selected subsequently and provided with the correct parameters to ensure the optimum adjustment of the display options. The procedure is described in the following.

The following submenu points are available:

MAN 100024488-EN Version: - Status: Released | freigegeben | Printed: 22.09.2017

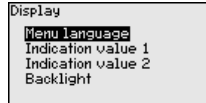

The submenu points described below.

**Display - Menu language**

This menu item enables the setting of the requested national language.

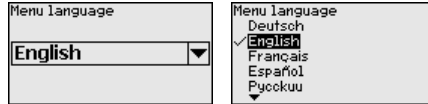

In the delivery status, the sensor is set to the ordered national language.

**Display - Displayed value 1**

In this menu item, you define the indication of the measured value on the display. You can display two different measured values. In this menu item, you define measured value 1.

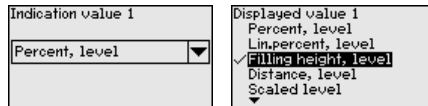

The default setting for the displayed value 1 is "Filling height Level".

**Display - Displayed value 2**

In this menu item, you define the indication of the measured value on the display. You can display two different measured values. In this menu item, you define measured value 2.

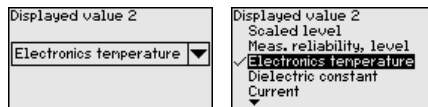

The default setting for the displayed value 2 is the electronics temperature.

**Display - Backlight**

The optionally integrated background lighting can be adjusted via the adjustment menu. The function depends on the height of the supply voltage, see "Technical data".



The lighting is switched off in delivery status.

**Diagnostics - Device status**

In this menu item, the device status is displayed.

46272-EN-140605

MAN 1000244883 EN Version: - Status: RL (released | freigegeben) printed: 2.09.2017

**Diagnostics - Peak values Distance**

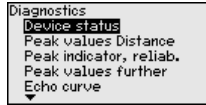

The respective min. and max. measured value is saved in the sensor. The two values are displayed in the menu item "*Peak values, distance*".

If you have selected interface measurement under the menu item "*Setup - Application*", the peak values of the interface measurement are displayed in addition to the peak values of the level measurement.

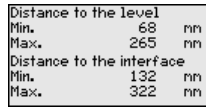
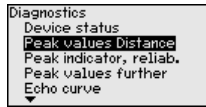

In another window you can carry out a reset of the two peak values separately.

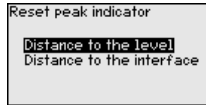

**Diagnostics - Peak values Measurement certainty**

The respective min. and max. measured values are saved in the sensor. The two values are displayed in the menu item "*Peak values, measurement certainty*".

The measurement can be influenced by the process conditions. In this menu item, the measurement certainty of the level measurement is displayed as percentage value. The higher the value, the more reliable the measurement. Values > 90 % indicate reliable measurement.

If you have selected interface measurement under the menu item "*Setup - Application*", the peak values of the interface measurement are displayed in addition to the peak values of the level measurement.

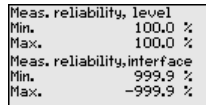
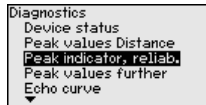

In another window you can carry out a reset of the two peak values separately.

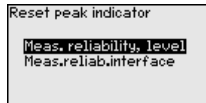

**Diagnostics - Peak values Additional**

The respective min. and max. measured values are saved in the sensor. The values are displayed in the menu item "*Peak values Additional*".

This menu item displays the peak values of the electronics temperature as well as the dielectric constant.

46272-EN-140605

MAN 000244883 EN Version: - Status: RL (released | freigegeben) printed: 22.09.2017

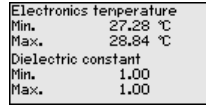
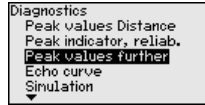

In another window you can carry out a reset of the two peak values separately.

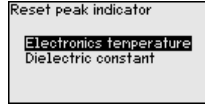

**Diagnostics - Echo curve**

The menu item "Echo curve" shows the signal strength of the echoes over the measuring range in V. The signal strength enables an evaluation of the quality of the measurement.

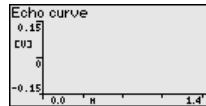
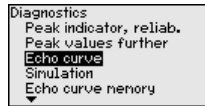

With the following functions you can zoom part sections of the echo curve.

- "X-Zoom": Zoom function for the meas. distance
- "Y-Zoom": 1, 2, 5 and 10x signal magnification in "V"
- "Unzoom": Reset the presentation to the nominal measuring range with single magnification

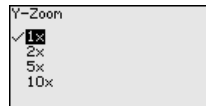
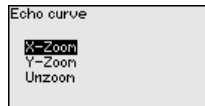

**Diagnostics - Simulation**

In this menu item you can simulate measured values via the current output. This allows the signal path to be tested, e.g. through downstream indicating instruments or the input card of the control system.

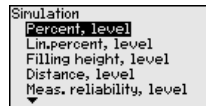
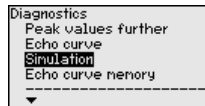

Select the requested simulation size and adjust the requested value.

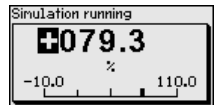
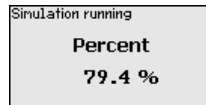
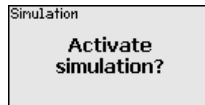

**Caution:**

During simulation, the simulated value is outputted as 4 ... 20 mA current value and digital HART signal.

Push the [ESC] key to deactivate the simulation.

MAN 1000244883 EN Version: - Status: RL (released | freigegeben) printed: 02.08.2017



**Information:**

The simulation is terminated automatically 60 minutes after the last key has been pressed.

**Diagnostics - Echo curve memory**

With the menu item "Setup" the echo curve it is possible to save at the time of setup. This is generally recommended; for using the Asset Management functions it is necessary. If possible, the curve should be saved with a low level in the vessel.

With this, you can detect signal changes over the operating time. With the adjustment software PACTware and the PC, the high-resolution echo curve can be displayed and used to compare the echo curve of the setup with the actual echo curve.

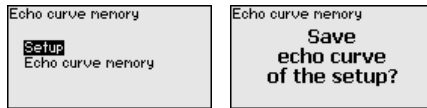

The function "Echo curve memory" enables storing echo curves of the measurement.

Under the sub-menu item "Echo curve memory" you can store the current echo curve.

Parameter settings for recording the echo curve and the settings of the echo curve itself can be carried out in the adjustment software PACTware.

With the adjustment software PACTware and the PC the high-resolution echo curve can be displayed and used later on to assess the quality of the measurement.

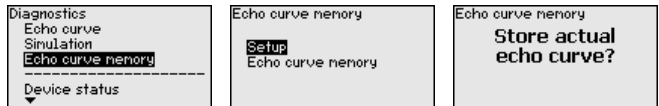

**Additional settings - PIN**

Entering a 4-digit PIN protects the sensor data against unauthorized access and unintentional modification. In this menu item, the PIN is displayed or edited and changed. However, this menu item is only available if adjustment is enabled in the menu "Lock/Release setup/adjustment".

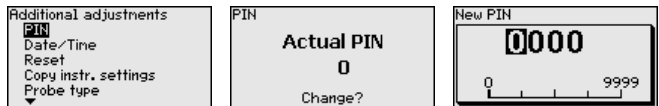

In delivery status, the PIN is "0000".

**Additional adjustments - Date Time**

In this menu item, the internal clock of the sensor is adjusted.

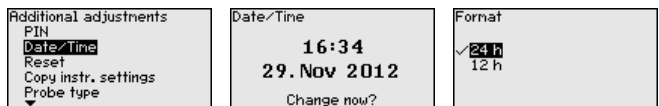

46272-EN-140605



Version: - Status: RL (released | freigegeben) printed: 22.09.2017

**Additional adjustments**  
- **reset**

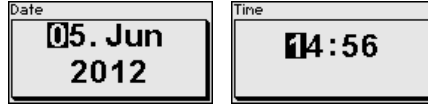

With a reset, certain parameter adjustments carried out by the user are reset.



The following reset functions are available:

**Delivery status:** Restoring the parameter settings at the time of shipment from the factory incl. the order-specific settings. A created false signal suppression, user-programmable linearization curve as well as the measured value memory will be deleted.

**Basic settings:** Resetting the parameter settings incl. special parameters to the default values of the respective instrument. Any stored false signal suppression, user programmable linearization curve as well as the measured value memory is deleted.

The following table shows the default values of the instrument. Depending on the instrument version or application, all menu items may not be available or some may be differently assigned:

**Setup**

Menu item	Default value	Modified value
Block adjustment	Released	
Measurement loop name	Sensor	
Units	Distance unit: mm Temperature unit: °C	
Probe length	Length of the probe Ex factory	
Type of medium	Liquid	
Application	Level, vessel	
Medium, dielectric constant	Water-based, > 10	
Superimposed gas phase	Yes	
Dielectric constant, upper medium (TS)	1.5	
Tube inner diameter	200 mm	
Max. adjustment - Level	100 %	
Max. adjustment - Level	Distance: 0.000 m(d) - note blocking distances	
Min. adjustment - Level	0 %	
Min. adjustment - Level	Distance: Probe length - take dead band into account	
Accept adjustment of the level measurement?	Yes	

46272-EN-140605

Menu item	Default value	Modified value
Max. adjustment - Interface	100 %	
Max. adjustment - Interface	Distance: 0.000 m(d) - note blocking distances	
Min. adjustment - Interface	0 %	
Min. adjustment - Interface	Distance: Probe length - take dead band into account	
Integration time - Level	0.0 s	
Integration time - Interface	0.0 s	
Linearization type	Linear	
Linearization - Socket correction	0 mm	
Linearization - Vessel height	Probe length	
Scaling size - Level	Volume in l	
Scaling unit - Level	Litres	
Scaling format - Level	Without decimal positions	
Scaling level - 100 % correspond to	100	
Scaling level - 0 % correspond to	0	
Accept scaling of the level measurement	Yes	
Scaling variable - Interface	Volume	
Scaling unit - Interface	Litres	
Scaling format - Interface	Without decimal positions	
Scaling interface - 100 % correspond to	100	
Scaling interface - 0 % correspond to	0	
Current output, output variable 1st HART variable (PV)	Lin. percent - Level	
Current output - Output characteristics	0 ... 100 % correspond to 4 ... 20 mA	
Current output - Reaction in case of failure	≤ 3.6 mA	
Current output - Min.	3.8 mA	
Current output - Max.	20.5 mA	
Current output 2 - Output variable Second HART variable (SV)	Distance - Level	
Current output 2 - Output characteristics	0 ... 100 % correspond to 4 ... 20 mA	
Current output 2 - Reaction in case of failure	≤ 3.6 mA	
Current output - Min.	3.8 mA	
Current output - Max.	20.5 mA	
Third HART variable (TV)	Measurement certainty, level	
Fourth HART variable (QV)	Electronics temperature	

**Display**

Menu item	Default value	Modified value
Language	Order-specific	
Displayed value 1	Filling height Level	
Displayed value 2	Electronics temperature	
Backlight	Switched off	

**Diagnostics**

Menu item	Default value	Modified value
Status signals - Function control	Switched on	
Status signals - Out of specification	Switched off	
Status signals - Maintenance	Switched off	
Device memory - Echo curve memory	Stopped	
Device memory - Measured value memory	Started	
Device memory - Measured value memory - Measured values	Distance level, percentage value level, reliability level, electronics temperature	
Device memory - Measured value memory - Recording in time interval	3 min.	
Device memory - Measured value memory - Recording with measured value difference	15 %	
Device memory - Measured value memory - Start with measured value	Not active	
Device memory - Measured value memory - Stop with measured value	Not active	
Device memory - Measured value memory - Stop recording when memory is full	Not active	

**Additional adjustments**

Menu item	Default value	Modified value
PIN	0000	
Date	Actual date	
Time	Actual time	
Time - Format	24 hours	
Probe type	Device-specific	

**Additional adjustments - Copy instrument settings**

The instrument settings are copied with this function. The following functions are available:

- Read from sensor: Read data from sensor and store into the display and adjustment module
- Write into sensor: Store data from the display and adjustment module back to the sensor

Status: RL (released | freigegeben) printed: 22.09.2017  
 Version: EN 44883  
 MAN 16

The following data or settings for adjustment of the display and adjustment module are saved:

- All data of the menu "Setup" and "Display"
- In the menu "Additional adjustments" the items "Reset, Date/Time"
- Special parameters



The copied data are permanently saved in an EEPROM memory in the display and adjustment module and remain there even in case of power failure. From there, they can be written into one or more sensors or kept as backup for a possible electronics exchange.



**Note:**

Before the data are stored in the sensor, a check is carried out to determine if the data fit the sensor. If the data do not fit, a fault signal is triggered or the function is blocked. When data are being written into the sensor, the display shows which instrument type the data originate from and which TAG-no. this sensor had.

**Additional adjustments - Probe type**

In this menu item you can select the type and size of your probe from a list of all possible probes. This is necessary to adapt the electronics optimally to the probe.

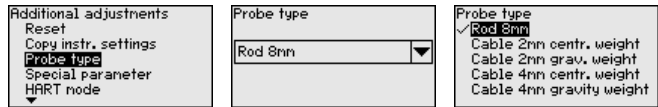

**Additional adjustments - Special parameters**

In this menu item you gain access to the protected area where you can enter special parameters. In exceptional cases, individual parameters can be modified in order to adapt the sensor to special requirements.

Change the settings of the special parameters only after having contacted our service staff.



**Additional adjustments - HART mode**

The sensor offers the HART modes "Analogue current output" and "Fix current (4 mA)". In this menu item you determine the HART mode and enter the address with Multidrop mode.

In the mode "Fixed current output" up to 63 sensors can be operated on one two-wire cable (Multidrop operation). An address between 0 and 63 must be assigned to each sensor.

If you select the function "Analogue current output" and also enter an address number, you can output a 4 ... 20 mA signal in Multidrop mode.

46272-EN-140605

With the mode "Fixed current (4 mA)" a fixed 4 mA signal is outputted independently of the actual level.

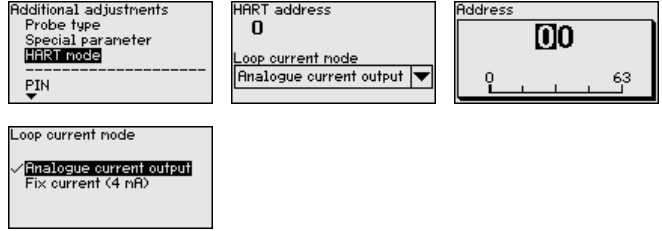

The default setting is "Analogue current output" and the address 00.

Info - Instrument name  
 Info - Instrument version  
 Info - Factory calibration date  
 Info - Sensor characteristics  
 Version: - Status: RL (released)  
 1000244883 EN  
 46272-EN-140605

**Info - Instrument name**

In this menu, you read out the instrument name and the instrument serial number.

**Info - Instrument version**

In this menu item, the hardware and software version of the sensor is displayed.



**Info - Factory calibration date**

In this menu item, the date of factory calibration of the sensor as well as the date of the last change of sensor parameters are displayed via the display and adjustment module or via the PC.



**Info - Sensor characteristics**

In this menu item, the features of the sensor such as approval, process fitting, seal, measuring range, electronics, housing and others are displayed.



**6.5 Saving the parameter adjustment data**

We recommended noting the adjusted data, e.g. in this operating instructions manual, and archiving them afterwards. They are thus available for multiple use or service purposes.

If the instrument is equipped with a display and adjustment module, the data in the sensor can be saved in the display and adjustment module. The procedure is described in the operating instructions manual "Display and adjustment module" in the menu item "Copy sensor data". The data remain there permanently even if the sensor power supply fails.

The following data or settings for adjustment of the display and adjustment module are saved:

- All data of the menu "*Setup*" and "*Display*"
- In the menu "*Additional adjustments*" the items "*Sensor-specific units, temperature unit and linearization*"
- The values of the user programmable linearization curve

The function can also be used to transfer settings from one instrument to another instrument of the same type. If it is necessary to exchange a sensor, the display and adjustment module is inserted into the replacement instrument and the data are likewise written into the sensor via the menu item "*Copy sensor data*".

## 7 Setup with PACTware

### 7.1 Connect the PC

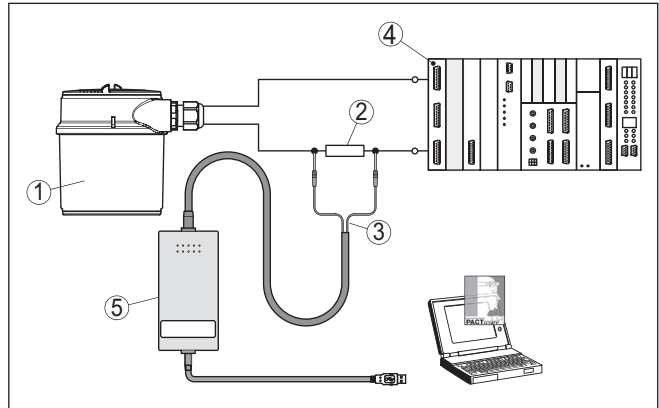

Fig. 15: Connecting the PC via HART to the signal cable

- 1 Sensor
- 2 HART resistance 250  $\Omega$  (optional depending on processing)
- 3 Connection cable with 2 mm pins and terminals
- 4 Processing system/PLC/Voltage supply

### 7.2 Parameter adjustment with PACTware

For parameter adjustment of the sensor via a Windows PC, the configuration software PACTware and a suitable instrument driver (DTM) according to FDT standard are required. The available DTMs are compiled on a DVD. The DTMs can also be integrated into other frame applications according to FDT standard.



**Note:**

To ensure that all instrument functions are supported, you should always use the latest DTM. Furthermore, not all described functions are included in older firmware versions. You can download the latest instrument software from our homepage. A description of the update procedure is also available in the Internet.

The further setup steps are described in the online help of PACTware and the DTMs.

MAN 100024483 EN Version: - Status: RL (released | freigegeben) printed: 2017-09-20  
 of the interface adapter and HART

Prerequisites

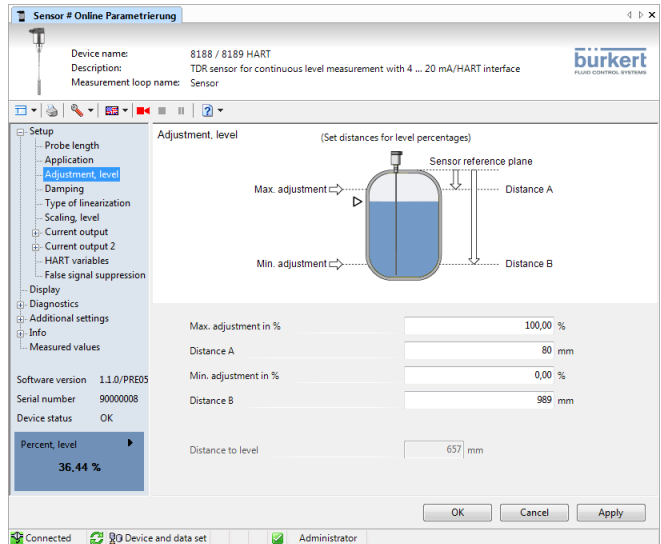

Fig. 16: Example of a DTM view

## Device DTMs

The device DTM includes an assistant for simple project configuration simplifying the adjustment considerably. You can save and print your project documentation as well as import and export projects.

You can also save measured value and echo curves in the DTM. Furthermore a tank calculation program as well as a multiviewer for indication and analysis of the saved measured value and echo curves are available.

The supplied DVD includes the respective device DTM. However, you can also download the DTM from our homepage [www.buerkert.com](http://www.buerkert.com).

## 7.3 Set up with the quick setup

The quick setup is another option for parameter adjustment of the sensor. It allows fast, convenient adjustment of the most important parameters to adapt the sensor quickly to standard applications. To use it, select the function "Quick setup" in the start screen.

## General information



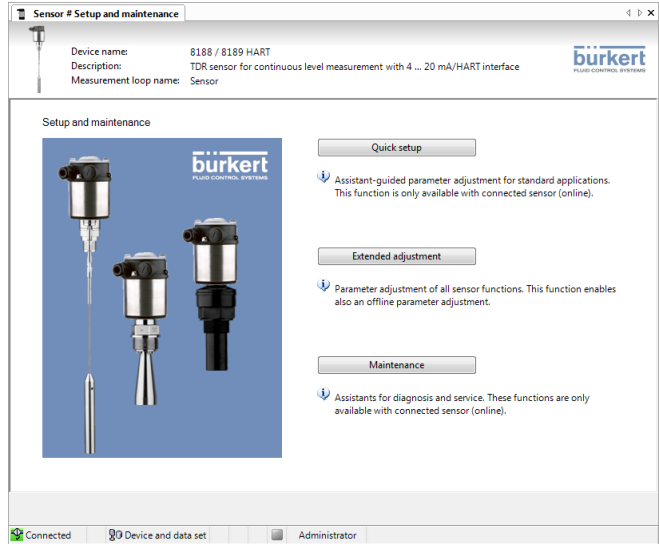

Fig. 17: Select quick setup

- 1 Quick setup
- 2 Extended adjustment
- 3 Maintenance

### Quick setup

With quick setup you can carry out the parameter adjustment of LEVEL TRANSMITTER 8189 for your application in just a few simple steps. The assistant-driven adjustment includes the basic settings for simple, reliable setup and commissioning.



### Information:

If the function is inactive, then possibly no instrument is connected. Check the connection to the instrument.

### Extended adjustment

With the extended adjustment, you carry out the parameter adjustment for the instrument via the clear menu structure in the DTM (Device Type Manager). This enables additional and special settings over and above those offered by quick setup.

### Maintenance

Under the menu item "Maintenance" you get comprehensive and important support for servicing and maintenance. You can call up diagnostic functions and carry out an electronics exchange or a software update.

### Start quick setup

Click to the button "Quick setup", to start the assistant-driven adjustment for a simplified and reliable setup.

## Step 1

### Instrument configuration

#### Device name

Here, you can find the instrument name. You cannot change this line because the instrument name is unmodifiably saved in the instrument.

#### Serial number

Here, you can find the serial number of your instrument. You cannot change this line because the serial number is unmodifiably saved in the instrument.

#### Measurement loop name

Here you can enter a suitable measurement loop name for your LEVEL TRANSMITTER 8189. You can enter a name with max. 19 characters. You can use capital and small letters as well as numbers. The following special characters are also possible: + - . : , ( ) / < >

#### Probe length modified?

If you have modified the probe length, this must be entered in the selection field.

- If you select "No", then the instrument uses automatically the preset length of the default setting.
- If you select "Yes", then you can enter in another field the modified length of the instrument.

#### Probe length L from seal surface

If you have modified the length of the probe, you can enter in this field the modified probe length. Keep the selected unit in mind.

#### Determine probe length automatically

If you do not know the probe length, you can have the length of the probe determined automatically. The requirement for this is a probe unrestricted and not covered by the medium.

Click to "*Carry out now*", to start the automatic length determination.

## Step 2

### Application

#### Type of medium

Here you can see which type of medium your instrument is suitable for. If this function is inactive, the medium type your instrument is suitable for was already preset.



#### Information:

In special cases you can change the type of medium. This setting can be changed under "*Extended adjustment*".

#### Application

In this field you can select the application you want to use your instrument for. You have the following selection options:

- Level in the vessel
- Level in the bypass/standpipe
- Interface in the vessel
- Interface in the bypass/standpipe
- Demonstration mode

*Level measurement:* If you select "Level", you can select the properties of the medium in another field.

*Interface measurement:* If you select "Interface", the instrument needs more information, such as the distance to the interface, the dielectric constant of the upper medium or whether or not there is a superimposed gas phase.

*Demonstration mode:* This mode is only suitable for test and demonstration purposes. In this mode, the sensor ignores all parameters and reacts immediately to all measured value changes within the measuring range.

### Application - Level measurement

The level measurement refers to the product surface which is the limit to the gas phase.

As a standard feature, the instrument is set to level measurement of liquids. You can switch over the instrument to the measurement of bulk solids.

- Liquids
  - Solvents, oils, LPG - dielectric constant < 3
  - Chemical mixtures - dielectric constant 3 ... 10
  - Water-based - dielectric constant > 10
- Bulk solids
  - Dusts, wood chips - dielectric constant < 1.5
  - Granules, dusts, powders - dielectric constant 1.5 ... 3
  - Cereals, flour - dielectric constant > 3

### Application - Interface measurement

The interface measurement refers to the phase limit between two liquids. The total level is also available as a measured value.

- Superimposed gas phase present
  - Check if there is a superimposed gas phase in the vessel. This is always the case if the total level never touches the process fitting.
- Properties
  - Here you can enter the dielectric constant of the upper medium
  - As an alternative you can enter the distance to the interface

## Step 3 Adjustment

### Adjustment for the level measurement

If you have selected level measurement in the previous menu, then you can enter the values for the min. and max. adjustment. The value to be entered refers to the distance from the sealing surface of the process fitting (sensor reference plane) to the surface of the product.

### Adjustment for the level and interface measurement

If you have selected interface measurement in the previous menu, then you can enter the values for the min. and max. adjustment of level and interface or accept the values of the level measurement. The entered value refers to the distance from the sealing surface of the process fitting (sensor reference plane) to the total level or interface.

Linearization is required if the measured value should be outputted in proportion to the volume and not the level. The linearization acts

## Step 7 Additional settings

## Step 5 Setting - Output signal

## Step 6 Sensor optimization

identically on the level and the interface measurement. You can find further linearization types in the extended adjustment.

If you have a non-linear vessel, you can select here the respective linearization curve.

- Linear
- Spherical tank
- Horizontal cylindrical tank

You must enter the following vessel dimensions with non-linear conditions:

- Height of the socket h
- Vessel height D

In this window you can adjust the output signal. When the function is inactive, you can change the settings via the "*Extended adjustment*".

These settings allow you to optimize the sensor. With them you can compare a sounded distance with the indicated value and correct it, if necessary.

### Probe immersed in the liquid (covered)

Select whether or not the probe is immersed in the medium.

### Measured distance to the medium

If the probe is immersed in the medium, you can enter here the measured distance to the medium.

### Displayed distance correct?

Is the displayed distance value correct? If you have the possibility, you can enter here the sounded distance to the medium.

### False signal suppression

With this function you can carry out the automatic false signal suppression. We recommend carrying out false signal suppression in any case.

When the setup of the instrument is finished, additional settings can be made. These are various backups and the locking of the instrument against unauthorised or inadvertent adjustment.

### Prepare a backup file of the instrument parameter adjustment?

For backup purposes, the current parameter adjustment of the instrument is stored in a file. You can use this file later on to restore the instrument parameter adjustment. The complete data set is downloaded from the device. This procedure can last several minutes.

### Create instrument documentation?

This function is used to print or create a PDF file of the current parameter adjustment. To read the PDF file, you need a suitable program (for example Acrobat Reader). To print or create the PDF file, all data are downloaded from the device. For this function, the full version of the DTM Collection is required. This procedure can last several minutes.

**Store echo curve of the setup in the sensor?**

Have you completed the initial setup of the instrument? In such case, we recommend storing the current signal conditions in the device for later instrument tests and diagnostics.

**Lock adjustment with PIN after setting?**

The instrument is locked with the current PIN. A parameter adjustment is possible only after the PIN is entered again.

**7.4 Saving the parameter adjustment data**

We recommend documenting or saving the parameter adjustment data via PACTware. That way the data are available for multiple use or service purposes.

## 8 Set up with other systems

### 8.1 DD adjustment programs

Device descriptions as Enhanced Device Description (EDD) are available for DD adjustment programs such as, for example, AMS™ and PDM.

### 8.2 Field Communicator 375, 475

Device descriptions for the instrument are available as EDD for parameter adjustment with the Field Communicator 375 or 475.

For the integration of the EDD in the Field Communicator 375 or 475, the software "Easy Upgrade Utility" is required which is available from the manufacturer. This software is updated via the Internet and new EDDs are automatically taken over into the device catalogue of this software after they are released by the manufacturer. They can then be transferred to a Field Communicator.

## 9 Diagnostics and service

### 9.1 Maintenance

If the device is used correctly, no maintenance is required in normal operation.

### 9.2 Diagnosis memory

The instrument has several memories which are available for diagnosis purposes. The data remain even with voltage interruption.

MA 1000244883 EN Version: - Status: RL (released | freigabe) printed: 22.09.2017  
**Measured value memory**

Up to 100,000 measured values can be stored in the sensor in a ring memory. Each entry contains date/time as well as the respective measured value. Storable values are for example:

- Distance
- Filling height
- Percentage value
- Lin. percent
- Scaled
- Current value
- Meas. reliability
- Electronics temperature

When the instrument is shipped, the measured value memory is active and stores distance, measurement certainty and electronics temperature every 3 minutes.

In "Extended adjustment" you can select the respective measured values.

The requested values and recording conditions are set via a PC with PACTware/DTM or the control system with EDD. Data are thus read out and also reset.

**Event memory**

Up to 500 events are automatically stored with a time stamp in the sensor (non-deletable). Each entry contains date/time, event type, event description and value. Event types are for example:

- Modification of a parameter
- Switch-on and switch-off times
- Status messages (according to NE 107)
- Error messages (according to NE 107)

The data are read out via a PC with PACTware/DTM or the control system with EDD.

**Echo curve memory**

The echo curves are stored with date and time and the corresponding echo data. The memory is divided into two sections:

**Echo curve of the setup:** This is used as reference echo curve for the measurement conditions during setup. Changes in the measurement conditions during operation or buildup on the sensor can thus be recognized. The echo curve of the setup is stored via:

- PC with PACTware/DTM
- Control system with EDD

## Status messages

- Display and adjustment module

**Further echo curves:** Up to 10 echo curves can be stored in a ring buffer in this memory section. Further echo curves are stored via:

- PC with PACTware/DTM
- Control system with EDD
- Display and adjustment module

### 9.3 Status messages

The instrument features self-monitoring and diagnostics according to NE 107 and VDI/VDE 2650. In addition to the status messages in the following tables there are more detailed error messages available under the menu item "Diagnostics" via the display and adjustment module, PACTware/DTM and EDD.

The status messages are divided into the following categories:

- Failure
- Function check
- Out of specification
- Maintenance requirement

and explained by pictographs:

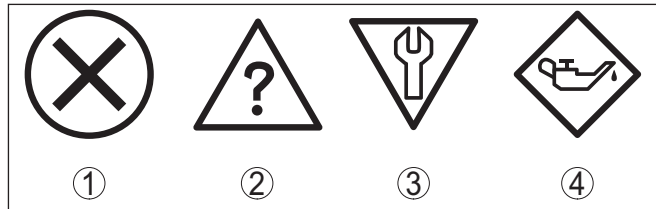

Fig. 18: Pictographs of the status messages

- 1 Failure - red
- 2 Out of specification - yellow
- 3 Function check - orange
- 4 Maintenance - blue

**Failure:** Due to a malfunction in the instrument, a failure message is outputted.

This status message is always active. It cannot be deactivated by the user.

**Function check:** The instrument is in operation, the measured value is temporarily invalid (for example during simulation).

This status message is inactive by default. It can be activated by the user via PACTware/DTM or EDD.

**Out of specification:** The measured value is unstable because the instrument specification is exceeded (e.g. electronics temperature).

This status message is inactive by default. It can be activated by the user via PACTware/DTM or EDD.

**Maintenance:** Due to external influences, the instrument function is limited. The measurement is affected, but the measured value is



**Failure**

still valid. Plan in maintenance for the instrument because a failure is expected in the near future (e.g. due to buildup).

This status message is inactive by default. It can be activated by the user via PACTware/DTM or EDD.

The following table shows the error codes in the status message "Failure" and gives information on the reason and rectification. Keep in mind that some information is only valid with four-wire instruments.

Code Text message	Cause	Rectification
F013 no measured value available	<ul style="list-style-type: none"> <li>- Sensor does not detect an echo during operation</li> <li>- Process component or probe contaminated or defective</li> </ul>	<ul style="list-style-type: none"> <li>- Check or correct installation and/or parameter adjustment</li> <li>- Clean or exchange process component or probe</li> </ul>
F017 Adjustment span too small	<ul style="list-style-type: none"> <li>- Adjustment not within specification</li> </ul>	<ul style="list-style-type: none"> <li>- Change adjustment according to the limit values (difference between min. and max. <math>\geq 10</math> mm)</li> </ul>
F025 Error in the linearization table	<ul style="list-style-type: none"> <li>- Index markers are not continuously rising, for example illogical value pairs</li> </ul>	<ul style="list-style-type: none"> <li>- Check values of the linearization table</li> <li>- Delete/create a new linearization table</li> </ul>
F036 No operable software	<ul style="list-style-type: none"> <li>- Failed or interrupted software update</li> </ul>	<ul style="list-style-type: none"> <li>- Repeat software update</li> <li>- Check electronics version</li> <li>- Exchanging the electronics</li> <li>- Send instrument for repair</li> </ul>
F040 Error in the electronics	<ul style="list-style-type: none"> <li>- Hardware defect</li> </ul>	<ul style="list-style-type: none"> <li>- Exchanging the electronics</li> <li>- Send instrument for repair</li> </ul>
F041 Probe loss	<ul style="list-style-type: none"> <li>- Cable probe broken or rod probe defective</li> </ul>	<ul style="list-style-type: none"> <li>- Check probe and exchange, if necessary</li> </ul>
F080 General software error	<ul style="list-style-type: none"> <li>- General software error</li> </ul>	<ul style="list-style-type: none"> <li>- Disconnect operating voltage briefly</li> </ul>
F105 Measured value is determined	<ul style="list-style-type: none"> <li>- The instrument is still in the start phase, the measured value could not yet be determined</li> </ul>	<ul style="list-style-type: none"> <li>- Wait for the end of the switch-on phase</li> <li>- Duration depending on the version and parameter adjustment max. 5 min.</li> </ul>
F113 Communication error	<ul style="list-style-type: none"> <li>- EMC interference</li> <li>- Transmission error with the external communication with 4-wire power supply unit</li> </ul>	<ul style="list-style-type: none"> <li>- Remove EMC influences</li> <li>- Exchange 4-wire power supply unit or electronics</li> </ul>

Code Text message	Cause	Rectification
F125 Impermissible electronics temperature	<ul style="list-style-type: none"> <li>- Temperature of the electronics in the non-specified section</li> </ul>	<ul style="list-style-type: none"> <li>- Check ambient temperature</li> <li>- Isolate electronics</li> <li>- Use instrument with higher temperature range</li> </ul>
F260 Error in the calibration	<ul style="list-style-type: none"> <li>- Error in the calibration carried out in the factory</li> <li>- Error in the EEPROM</li> </ul>	<ul style="list-style-type: none"> <li>- Exchanging the electronics</li> <li>- Send instrument for repair</li> </ul>
F261 Error in the instrument settings	<ul style="list-style-type: none"> <li>- Error during setup</li> <li>- Error when carrying out a reset</li> <li>- False signal suppression faulty</li> </ul>	<ul style="list-style-type: none"> <li>- Carry out a reset</li> <li>- Repeat setup</li> </ul>
F264 Installation/ Setup error	<ul style="list-style-type: none"> <li>- Error during setup</li> </ul>	<ul style="list-style-type: none"> <li>- Check or correct installation and/or parameter adjustment</li> <li>- Check probe length</li> </ul>
F265 Measurement function disturbed	<ul style="list-style-type: none"> <li>- Sensor no longer carries out a measurement</li> </ul>	<ul style="list-style-type: none"> <li>- Carry out a reset</li> <li>- Disconnect operating voltage briefly</li> </ul>
F266 Impermissible operating voltage	<ul style="list-style-type: none"> <li>- Operating voltage below specified range</li> </ul>	<ul style="list-style-type: none"> <li>- Check electrical connection</li> <li>- if necessary, increase operating voltage</li> </ul>
F267 No executable sensor software	<ul style="list-style-type: none"> <li>- Sensor cannot start</li> </ul>	<ul style="list-style-type: none"> <li>- Exchanging the electronics</li> <li>- Send instrument for repair</li> </ul>

### Function check

The following table shows the error codes and text messages in the status message "*Function check*" and provides information on causes as well as corrective measures.

Code Text message	Cause	Rectification
C700 Simulation active	<ul style="list-style-type: none"> <li>- A simulation is active</li> </ul>	<ul style="list-style-type: none"> <li>- Finish simulation</li> <li>- Wait for the automatic end after 60 mins.</li> </ul>

### Out of specification

The following table shows the error codes and text messages in the status message "*Out of specification*" and provides information on causes as well as corrective measures.

**Maintenance**

Code Text message	Cause	Rectification
S600 Impermissible electronics temperature	– Temperature of the electronics in the non-specified section	– Check ambient temperature – Isolate electronics – Use instrument with higher temperature range
S601 Overfilling	– Danger of vessel overfilling	– Make sure that there is no further filling – Check level in the vessel
S603 Impermissible operating voltage	– Operating voltage below specified range	– Check electrical connection – if necessary, increase operating voltage

The following table shows the error codes and text messages in the status message "Maintenance" and provides information on causes as well as corrective measures.

Code Text message	Cause	Rectification
M500 Error with the reset delivery status	– With the reset to delivery status, the data could not be restored	– Repeat reset – Load XML file with sensor data into the sensor
M501 Error in the non-active linearization table	– Hardware error EEPROM	– Exchanging the electronics – Send instrument for repair
M502 Error in the diagnosis memory	– Hardware error EEPROM	– Exchanging the electronics – Send instrument for repair
M503 Reliability too low	– The echot/noise ratio is the small for a reliable measurement	– Check installation and process conditions – Clean the antenna – Change polarisation direction – Use instrument with higher sensitivity
M504 Error on an device interface	– Hardware defect	– Check connections – Exchanging the electronics – Send instrument for repair

MAN 1000244883 (Version: - Status: RL (revised) (Freigegeben) printed: 22.09.2017)

Code Text message	Cause	Rectification
M505 No echo available	– Level echo can no longer be detected	– Clean the antenna – Use a more suitable antenna/sensor – Remove possible false echoes – Optimize sensor position and orientation

**Reaction when malfunctions occur**

**Procedure for fault rectification**

**9.4 Rectify faults**

The operator of the system is responsible for taking suitable measures to rectify faults.

The first measures are:

- Evaluation of fault messages, for example via the display and adjustment module
- Checking the output signal
- Treatment of measurement errors

Further comprehensive diagnostics options are available with a PC with PACTware and the suitable DTM. In many cases, the reasons can be determined in this way and faults rectified.

**Check the 4 ... 20 mA signal**

Connect a multimeter in the suitable measuring range according to the wiring plan. The following table describes possible errors in the current signal and helps to remove them:

Error	Cause	Rectification
4 ... 20 mA signal not stable	– Fluctuations of the measured variable	– Set damping according to the instrument via the display and adjustment module or PACTware/DTM
4 ... 20 mA signal missing	– Electrical connection faulty	– Check connection according to chapter "Connection steps" and if necessary, correct according to chapter "Wiring plan"
	– Voltage supply missing	– Check cables for breaks; repair if necessary
	– Operating voltage too low or load resistance too high	– Check, adapt if necessary
Current signal greater than 22 mA or less than 3.6 mA	– Electronics module in the sensor defective	– Exchange the instrument or send it in for repair

**Treatment of measurement errors**

The below tables show typical examples for application-relevant measurement errors. There are two measurement errors:

- Constant level

46272-EN-140605

- Filling
- Emptying

The images in column "Error pattern" show the real level with a broken line and the level displayed by the sensor as a continuous line.

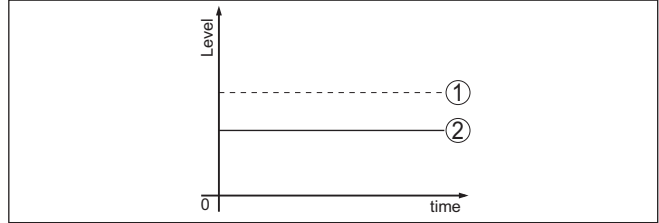

Fig. 19: The broken line 1 shows the real level, the continuous line 2 shows the level displayed by the sensor



**Note:**

- Wherever the sensor displays a constant value, the reason could also be the fault setting of the current output to "Hold value"
- In case of a too low level indication, the reason could be a line resistance that is too high

**Measurement error with constant level**

Fault description	Error pattern	Cause	Rectification
1. Measured value shows a too low or too high level		- Min./max. adjustment not correct	- Adapt min./max. adjustment
		- Wrong linearization curve	- Adapt linearization curve
		- Running time error (small measurement error close to 100 %/serious error close to 0 %)	- Repeat setup
2. Measured value jumps towards 100 %		- Due to the process, the amplitude of the product echo sinks	- Carry out a false signal suppression
		- A false signal suppression was not carried out	
		- Amplitude or position of a false signal has changed (e.g. buildup); false signal suppression no longer matches	- Determine the reason for the changed false signals, carry out false signal suppression, e.g. with buildup

**Measurement error during filling**

Fault description	Error pattern	Cause	Rectification
3. Measured value remains in the area of the bottom during filling		- Echo from the probe end larger than the product echo, for example, with products with $\epsilon_r < 2.5$ oil-based, solvents, etc.	- Check parameter "Medium" and "Vessel height", adapt if necessary

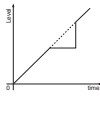
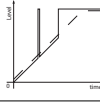
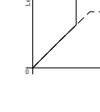
Fault description	Error pattern	Cause	Rectification
7 Measured value remains momentarily unchanged during filling and then jumps to the correct level		– Turbulence on the product surface, quick filling	– Check parameters, change if necessary, e.g. in dosing vessel, reactor
8 Measured value jumps sporadically to 100 % during filling		– Changing condensation or contamination on the probe	– Carry out a false signal suppression
9 Measured value jumps to $\geq 100\%$ or 0 m distance		– Level echo is no longer detected in the close range due to false signals in the close range. The sensor goes into overflow protection mode. The max. level (0 m distance) as well as the status message "Overflow protection" are outputted.	– Eliminate false signals in the close range – Check installation conditions – If possible, switch off the function "Overflow protection"

### Measurement error during emptying

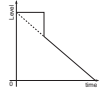
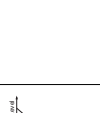
Fault description	Error pattern	Cause	Rectification
7 Measured value remains unchanged in the close range during emptying		– False echo larger than the level echo – Level echo too small	– Eliminate false signals in the close range – Remove contamination on the probe. After having removed the source of the false signals, the false signal suppression must be deleted. – Carry out a new false signal suppression
8 Measured value remains reproducible in one position during emptying		– Stored false signals in this position are larger than the level echo	– Delete false signal memory – Carry out a new false signal suppression

### Reaction after fault rectification

Depending on the reason for the fault and the measures taken, the steps described in chapter "Setup" must be carried out again or must be checked for plausibility and completeness.

## 9.5 Exchanging the electronics module

If the electronics module is defective, it can be replaced by the user.



In Ex applications, only instruments and electronics modules with appropriate Ex approval may be used.

If there is no electronics module available on site, the electronics module can be ordered through the agency serving you. The electronics modules are adapted to the respective sensor and differ in signal output or voltage supply.

The new electronics module must be loaded with the default settings of the sensor. These are the options:

- In the factory
- Or on site by the user

In both cases, the serial number of the sensor is needed. The serial numbers are stated on the type label of the instrument, on the inside of the housing as well as on the delivery note.

When loading on site, first of all the order data must be downloaded from the Internet (see operating instructions manual "*Electronics module*").

**Caution:**

All user-specific settings must be entered again. Hence, you have to carry out a new setup after the electronics exchange.

If you have stored the data of the parameter adjustment during the first setup of the sensor, you can transfer these to the replacement electronics module. A new setup is no more necessary.

## 9.6 Software update

The following components are required to update the sensor software:

- Sensor
- Voltage supply
- HART modem
- PC with PACTware
- Current sensor software as file

You can find the actual sensor software as well as detailed information of the procedure in the download area on our homepage: [www.buerkert.com](http://www.buerkert.com).

You can find information about the installation in the download file.

**Caution:**

Instruments with approvals can be bound to certain software versions. Therefore make sure that the approval is still effective after a software update is carried out.

You can find detailed information in the download area on our homepage: [www.buerkert.com](http://www.buerkert.com).

## 9.7 How to proceed if a repair is needed

If it is necessary to repair the instrument, please contact the agency serving you.

## 10 Dismounting

### 10.1 Dismounting steps

**Warning:**

Before dismounting, be aware of dangerous process conditions such as e.g. pressure in the vessel or pipeline, high temperatures, corrosive or toxic products etc.

Take note of chapters "*Mounting*" and "*Connecting to power supply*" and carry out the listed steps in reverse order.

### 10.2 Disposal

The instrument consists of materials which can be recycled by specialised recycling companies. We use recyclable materials and have designed the parts to be easily separable.

Correct disposal avoids negative effects on humans and the environment and ensures recycling of useful raw materials.

Materials: see chapter "*Technical data*"

If you have no way to dispose of the old instrument properly, please contact us concerning return and disposal.

**WEEE directive 2002/96/EG**

This instrument is not subject to the WEEE directive 2002/96/EG and the respective national laws. Pass the instrument directly on to a specialised recycling company and do not use the municipal collecting points. These may be used only for privately used products according to the WEEE directive.



## 11 Supplement

### 11.1 Technical data

#### General data

316L corresponds to 1.4404 or 1.4435

Materials, wetted parts

Process fitting	PTFE
Process seal	PTFE
Rod: ø 10 mm (0.394 in)	316L, PFA coated
Cable: ø 4 mm (0.157 in)	316 (1.4401), PFA-beschichtet
Gravity weight	PFA coated

Materials, non-wetted parts

Housing	plastic PBT (Polyester), 316L
Seal between housing and housing cover	Silicone
Inspection window in housing cover (optional)	Polycarbonate
Ground terminal	316L

Process fittings

Clamp	from 2"
Slotted nut	from DN 32 PN 40
Flanges	e.g. DIN from DN 25, ANSI from 2"

Weight

Instrument weight (depending on process fitting)	approx. 0.8 ... 8 kg (0.176 ... 17.64 lbs)
Rod: ø 10 mm (0.394 in) - PFA coated	approx. 330 g/m (3.55 oz/ft)
Cable: ø 4 mm (0.157 in) - PFA coated	approx. 41 g/m (0.44 oz/ft)
Gravity weight (long) for cable ø 4 mm (0.157 in)	325 g (11.5 oz)

Probe length L (from seal surface)

- Rod: ø 10 mm (0.394 in) - PFA coated	up to 4 m (13.12 ft)
- Trimming accuracy - rod	±(1 mm + 0.05 % of the rod length)
- Cable: ø 4 mm (0.157 in) - PFA coated	up to 32 m (105 ft)
- Trimming accuracy - cable	±(2 mm + 0.05 % of the cable length)

Lateral load with rod: ø 10 mm (0.394 in) - PFA coated 4 Nm (3 lbf ft)

Max. tensile load with cable: ø 4 mm (0.157 in) - PFA coated 2 KN (450 lbf)

Torque for NPT cable glands and Conduit max. 10 Nm (7.376 lbf ft) tubes

#### Input variable

Measured variable	Level of liquids
-------------------	------------------

Min. dielectric constant of the medium

Cable probes	$\epsilon_r \geq 1.6$
Rod probes	$\epsilon_r \geq 1.6$

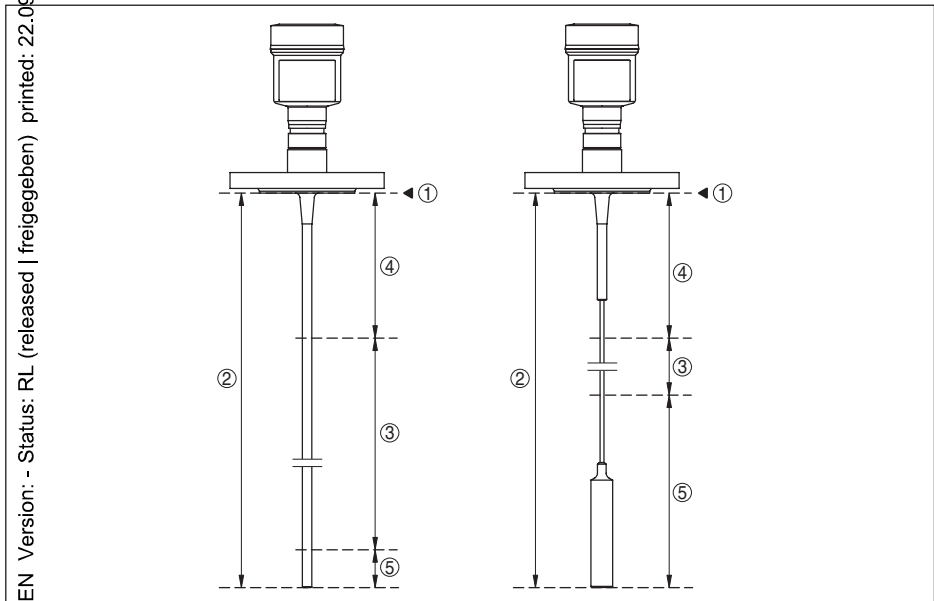

Fig. 28: Measuring ranges - LEVEL TRANSMITTER 8189

- 1 Reference plane  
 2 Probe length L  
 3 Measuring range (default setting refers to the measuring range in water)  
 4 Upper dead band (see diagrams under Accuracy - grey section)  
 5 Lower dead band (see diagrams under Accuracy - grey section)

### Output variable

Output signal	4 ... 20 mA/HART
Range of the output signal	3.8 ... 20.5 mA/HART (default setting)
Fulfilled HART specification	7
Signal resolution	0.3 $\mu$ A
Failure signal current output (adjustable)	Last valid measured value, $\geq 21$ mA, $\leq 3.6$ mA
Max. output current	21.5 mA
Starting current	$\leq 10$ mA for 5 ms after switching on, $\leq 3.6$ mA
Load	see load under Power supply
Damping (63 % of the input variable), adjustable	0 ... 999 s
HART output values according to HART 7 (default setting) <sup>1)</sup>	
– First HART value (PV)	Linearised percentage value, level

<sup>1)</sup> The output values can be assigned individually

- Second HART value (SV)	Distance to the level
- Third HART value (TV)	Measurement certainty, level
- Fourth HART value (QV)	Electronics temperature
Indication value - Display and adjustment module <sup>2)</sup>	
- Displayed value 1	Filling height Level
- Displayed value 2	Electronics temperature
Resolution, digital	< 1 mm (0.039 in)

**Accuracy (according to DIN EN 60770-1)**

Process reference conditions according to DIN EN 61298-1

Temperature	+18 ... +30 °C (+64 ... +86 °F)
Relative humidity	45 ... 75 %
Air pressure	+860 ... +1060 mbar/+86 ... +106 kPa (+12.5 ... +15.4 psig)

Installation reference conditions

Min. distance to installations	> 500 mm (19.69 in)
Vessel	metallic, ø 1 m (3.281 ft), centric installation, process fitting flush with the vessel ceiling
Medium	Water/Oil (dielectric constant ~2.0) <sup>3)</sup>
Installation	Probe end does not touch the vessel bottom
Sensor parameter adjustment	No gating out of false signals carried out
Typical deviation - Interface measurement	± 5 mm (0.197 in)
Typical deviation - Total level interface measurement	See following diagrams
Typical deviation - Level measurement <sup>4)5)</sup>	See following diagrams

<sup>2)</sup> The indication values can be assigned individually

<sup>3)</sup> With interface measurement = 2.0

<sup>4)</sup> Depending on the installation conditions, there can be deviations which can be rectified with an adaptation of the adjustment or a change of the measured value offset in the DTM service mode

<sup>5)</sup> The dead bands can be optimized by a false signal suppression.

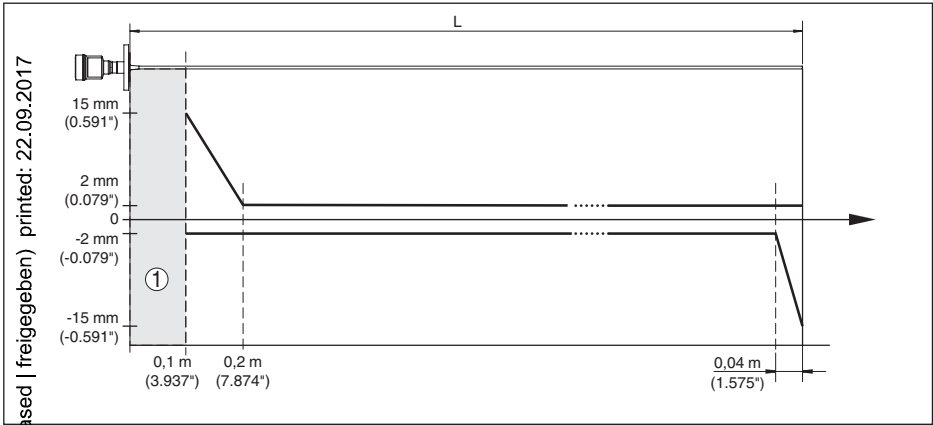

Fig. 29: Deviation LEVEL TRANSMITTER 8189 in rod version (coated) in water

1 Dead band - no measurement possible in this area

L Probe length

Deviation - level measurement from 6 m 0.5 % of the probe length  
probe length

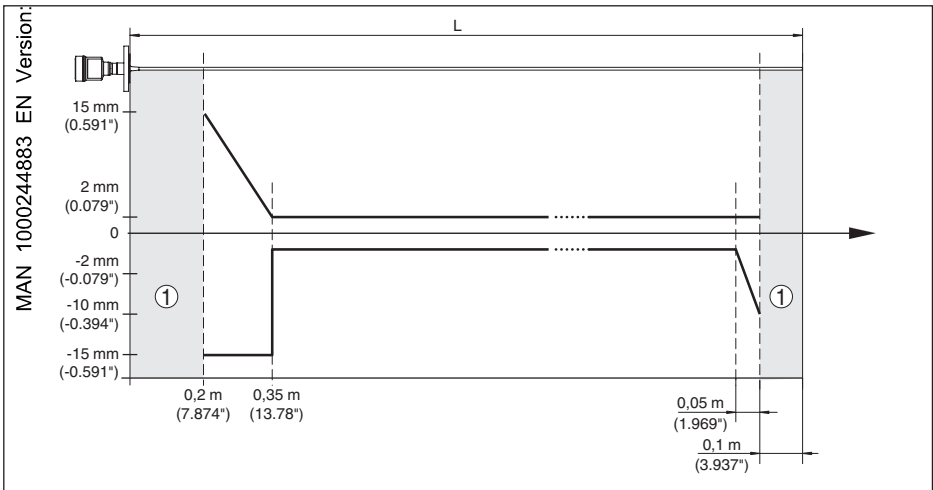

Fig. 30: Deviation LEVEL TRANSMITTER 8189 in rod version (coated) in oil

1 Dead band - no measurement possible in this area

L Probe length

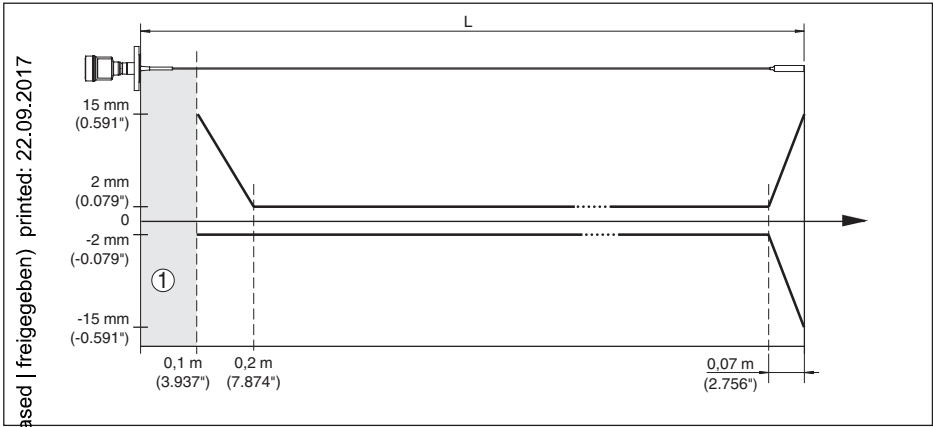

Fig. 31: Deviation LEVEL TRANSMITTER 8189 in cable version (coated) in water

1 Dead band - no measurement possible in this area  
L Probe length

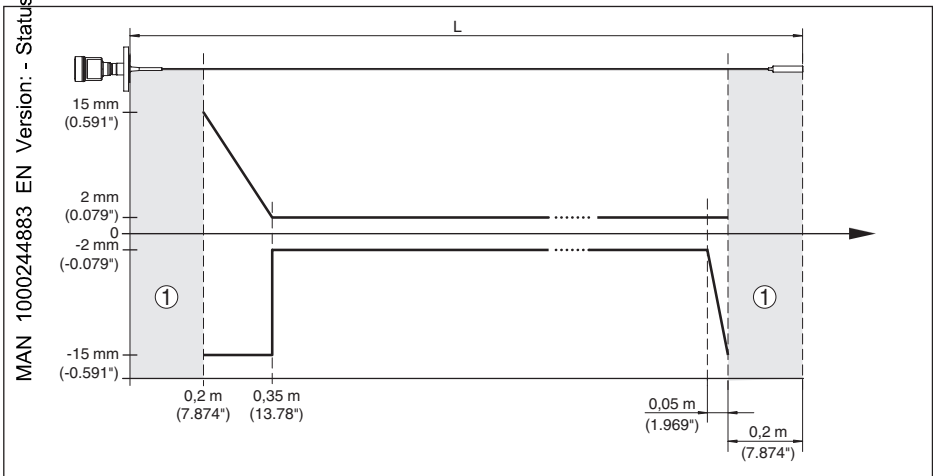

Fig. 32: Deviation LEVEL TRANSMITTER 8189 in cable version (coated) in oil

1 Dead band - no measurement possible in this area  
L Probe length

Repeatability  $\leq \pm 1$  mm

**Variables influencing measurement accuracy**

**Specifications for the digital measured value**

Temperature drift - Digital output  $\pm 3$  mm/10 K relating to the max. measuring range or max. 10 mm (0.394 in)

Additional deviation through electromagnetic interference acc. to EN 61326  $< \pm 10$  mm ( $< \pm 0.394$  in)

### Specifications apply also to the current output<sup>6)</sup>

Temperature drift - Current output	$\pm 0.03 \%$ /10 K relating to the 16 mA span max. $\pm 0.3 \%$
Deviation on the current output through analogue/digital conversion	$< \pm 15 \mu\text{A}$
Additional deviation through electromagnetic interference acc. to EN 61326	$< \pm 150 \mu\text{A}$

### Influence of the superimposed gas and pressure to the accuracy

The propagation speed of the radar impulses in gas or vapour above the medium is reduced by high pressure. This effect depends on the superimposed gas or vapour and is especially large at low temperatures.

The following table shows the resulting deviation for some typical gases and vapours. The specified values refer to the distance. Positive values mean that the measured distance is too large, negative values that the measured distance is too small.

Gas phase	Temperature	Pressure		
		1 bar (14.5 psig)	10 bar (145 psig)	50 bar (725 psig)
Air	20 °C/68 °F	0.00 %	0.22 %	1.2 %
	200 °C/392 °F	-0.01 %	0.13 %	0.74 %
	400 °C/752 °F	-0.02 %	0.08 %	0.52 %
Hydrogen	20 °C/68 °F	-0.01 %	0.10 %	0.61 %
	200 °C/392 °F	-0.02 %	0.05 %	0.37 %
	400 °C/752 °F	-0.02 %	0.03 %	0.25 %
Steam (saturated steam)	100 °C/212 °F	0.26 %	-	-
	180 °C/356 °F	0.17 %	2.1 %	-
	264 °C/507 °F	0.12 %	1.44 %	9.2 %
	366 °C/691 °F	0.07 %	1.01 %	5.7 %

### Characteristics and performance data

Measuring cycle time	$< 500 \text{ ms}$
Step response time <sup>7)</sup>	$\leq 3 \text{ s}$
Max. filling/emptying speed	1 m/min

### Ambient conditions

Ambient, storage and transport temperature -40 ... +80 °C (-40 ... +176 °F)

### Process conditions

For the process conditions, please also note the specifications on the type label. The lowest value always applies.

The measurement error through the process conditions in the specified pressure and temperature range is  $< 1 \%$ .

<sup>6)</sup> Also for the additional current output (optional)

<sup>7)</sup> Time span after a sudden measuring distance change by max. 0.5 m in liquid applications, max 2 m with bulk solids applications, until the output signal has taken for the first time 90 % of the final value (IEC 61298-2).

Process pressure

Clamp, flange version ≤ 2"/DN 50	-0.5 ... +16 bar/-50 ... +1600 kPa (-7.3 ... +232 psig), depending on the process fitting
Clamp, flange version > 2"/DN 50	-0.2 ... +16 bar/-20 ... +1600 kPa (-2.9 ... +232 psig), depending on the process fitting

Vessel pressure relating to the flange nominal stage see supplementary instructions manual "Flanges according to DIN-EN-ASME-JIS"

Process temperature (thread or flange temperature)

-FKM (SHS FPM 70C3 GLT)	-40 ... +150 °C (-40 ... +302 °F)
-EPDM (A+P 75.5/KW75F)	-40 ... +150 °C (-40 ... +302 °F)

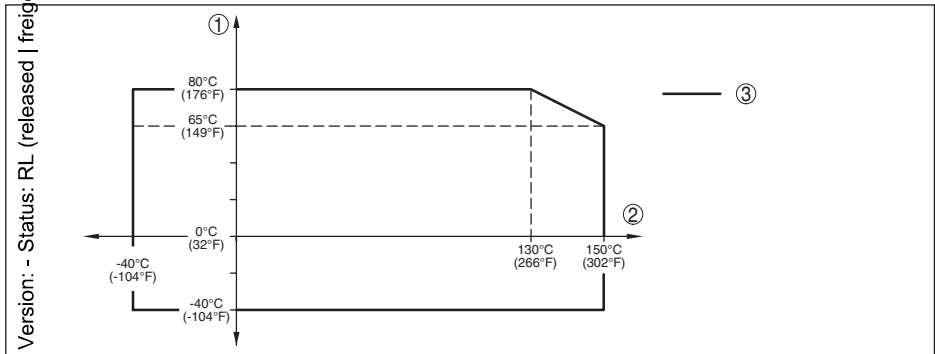

Fig. 33: Ambient temperature - process temperature, standard version

- 1 Ambient temperature
- 2 Process temperature (depending on the seal material)
- 3 Maximum permissible temperature - standard

Vibration resistance

- Instrument housing	4 g at 5 ... 200 Hz according to EN 60068-2-6 (vibration with resonance)
- Rod probe	1 g with 5 ... 200 Hz according EN 60068-2-6 (vibration at resonance) with rod length 50 cm (19.69 in)

Shock resistance

- Instrument housing	100 g, 6 ms according to EN 60068-2-27 (mechanical shock)
- Rod probe	25 g, 6 ms according to EN 60068-2-27 (mechanical shock) with rod length 50 cm (19.69 in)

**Electromechanical data - version IP 66/IP 67 and IP 66/IP 68; 0.2 bar**

Cable gland	M20 x 1.5 or ½ NPT
Wire cross-section (spring-loaded terminals)	
- Massive wire, cord	0.2 ... 2.5 mm <sup>2</sup> (AWG 24 ... 14)
- Stranded wire with end sleeve	0.2 ... 1.5 mm <sup>2</sup> (AWG 24 ... 16)

46272-EN-140605

---

**Display and adjustment module**

---

Display element	Display with backlight
Measured value indication	
Number of digits	5
Size of digits	W x H = 7 x 13 mm
Adjustment elements	4 keys
Protection rating	
Unassembled	IP 20
Mounted into the housing without cover	IP 40
Materials	
Housing	ABS
Inspection window	Polyester foil

---

**Integrated clock**

---

Date format	Day.Month.Year
Time format	12 h/24 h
Time zone Ex factory	CET
Rate deviation max.	10.5 min/year

---

**Measurement electronics temperature**

---

Resolution	1 °C (1.8 °F)
Accuracy	±1 °C (1.8 °F)
Permissible temperature range	-40 ... +85 °C (-40 ... +185 °F)

---

**Voltage supply**

---

Operating voltage	
– Non-Ex instrument, Ex-d instrument	9.6 ... 35 V DC
– Ex-ia instrument	9.6 ... 30 V DC
– Ex-d-ia instrument	15 ... 35 V DC
Operating voltage with illuminated display and adjustment module	
– Non-Ex instrument, Ex-d instrument	16 ... 35 V DC
– Ex-ia instrument	16 ... 30 V DC
– Ex-d-ia instrument	20 ... 35 V DC
Interpolation protection	Integrated
Permissible residual ripple - Non-Ex, Ex-ia instrument	
– Frequency	16 ... 400 Hz
– for 12 V < U <sub>N</sub> < 18 V	≤ 0.7 V <sub>eff</sub>
– for 18 V < U <sub>N</sub> < 35 V	≤ 1.0 V <sub>eff</sub>
Permissible residual ripple - Ex-d-ia instrument	
– Frequency	16 ... 400 Hz
– for 18 V < U <sub>N</sub> < 35 V	≤ 1.0 V <sub>eff</sub>



Load resistor

Calculation	$(U_B - U_{min})/0.0215 A$
Example - Non-Ex instrument with $U_B = 24 V DC$	$(24 V - 9.6 V)/0.0215 A = 670 \Omega$

**Electrical protective measures**

Protection rating	IP 66/IP 67 (NEMA 4X)
Overvoltage category	III <sup>8)</sup>
Protection class	III <sup>9)</sup>

**Approvals**

Instruments with approvals can have deviating technical data (depending on the version). For such instruments, the corresponding approval documents must be noted.

**1.2 Dimensions**

**Housing**

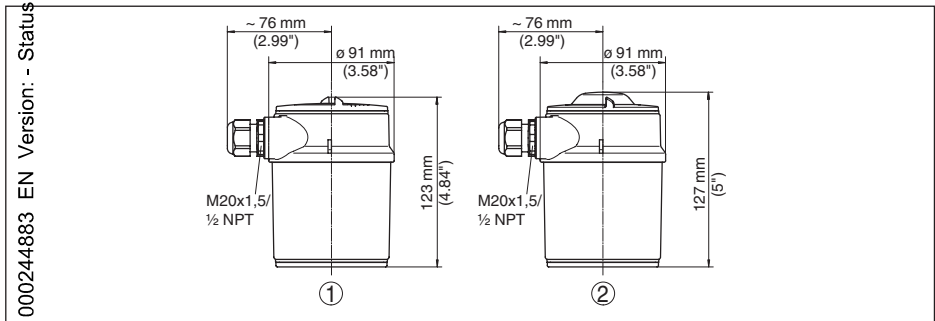

Fig. 34: Housing versions in protection IP 66/IP 68 (0.2 bar) - with integrated display and adjustment module the housing is 4 mm/0.16 in higher

- 1 Housing without display and adjustment module
- 2 Housing with transparent cover for display and adjustment module

<sup>8)</sup> IEC 61010-1

<sup>9)</sup> IEC 61010-1

**LEVEL TRANSMITTER 8189, cable version  $\varnothing$  4 mm (0.157 in) - PFA coated**

Fig. 35: LEVEL TRANSMITTER 8189, cable version with gravity weight

- L* Sensor length, see chapter "Technical data"  
 1 Cable version,  $\varnothing$  4 mm (0.157 in) with flange  
 2 Cable version with Clamp  
 3 Cable version with slotted nut

**LEVEL TRANSMITTER 8189, rod version  $\varnothing$  10 mm (0.394 in) - PFA coated**

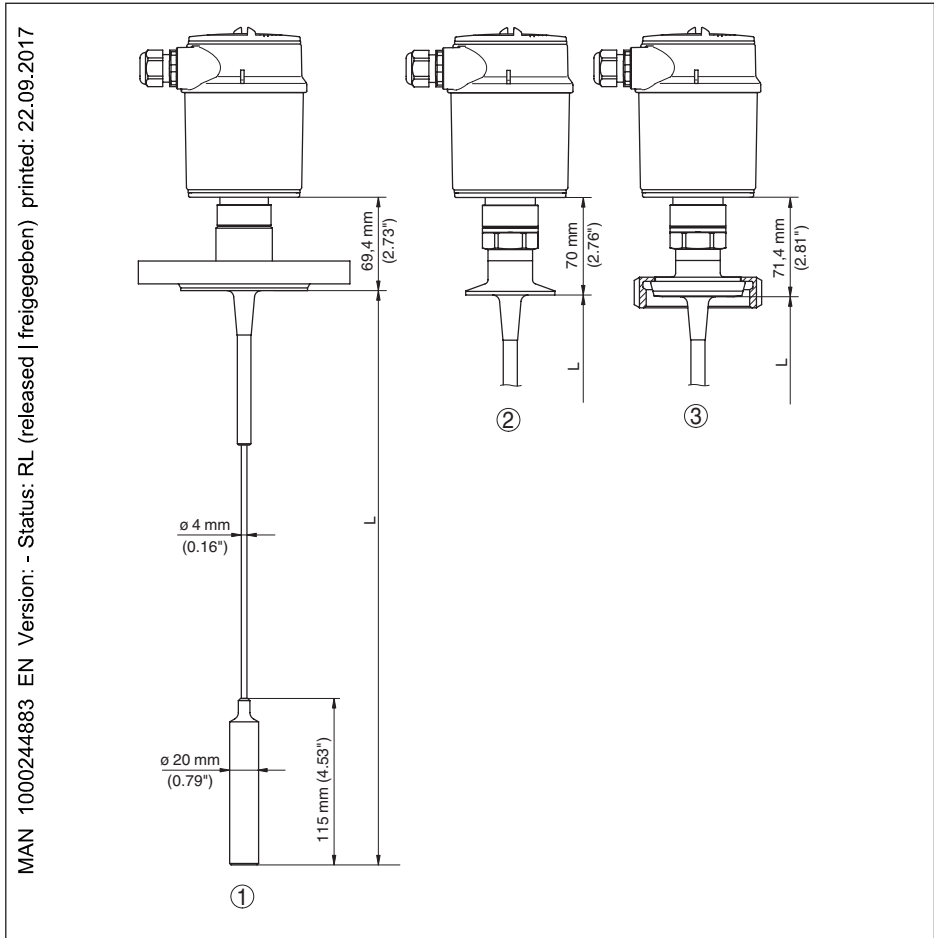
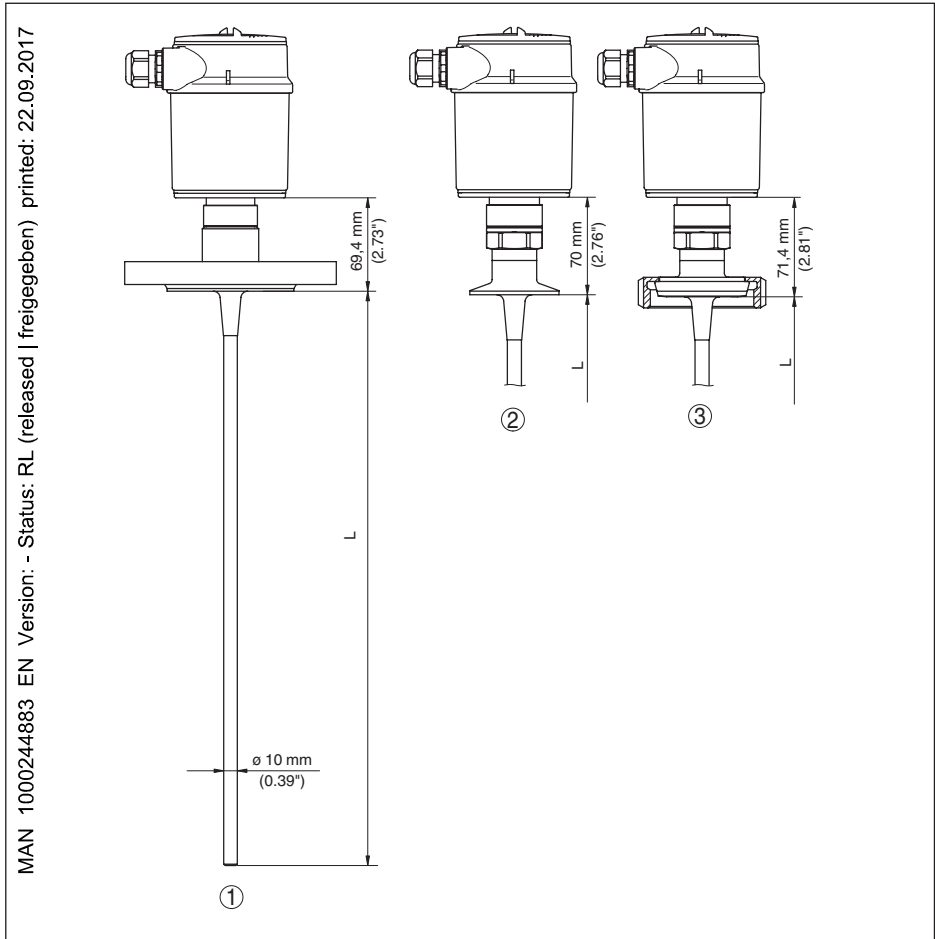

Fig. 36: LEVEL TRANSMITTER 8189, rod version

- L Sensor length, see chapter "Technical data"
- 1 Rod version,  $\varnothing$  10 mm (0.394 in) with flange
- 2 Rod version with Clamp
- 3 Rod version with slotted nut

### 11.3 Trademark

All the brands as well as trade and company names used are property of their lawful proprietor/  
originator.

MAN 1000244883 EN Version: - Status: RL (released | freigegeben) printed: 22.09.2017

## INDEX

**A**

- Accessories
  - Display and adjustment module 10
- Adjustment
  - Max. adjustment 29, 30
  - Min. adjustment 29, 30
- Adjustment system 23
- Application 28, 29
- Application area 8

**B**

- Backlight 37
- Back adjustment 36

**C**

- Check output signal 60
- Connecting
  - Electrically 19
- Connection
  - Cable 18
  - Steps 19
  - Technology 19
- Copy sensor settings 43
- Current output 2 34
- Current output, adjustment 34
- Current output Min./Max. 34
- Current output mode 34
- Current output, size 33
- Curve indication
  - Echo curve 39

**D**

- Damping 31
- Date of manufacture 45
- Date/Time 40
- Default values 41
- Deviation 60

**E**

- Echo curve memory 55
- Echo curve of the setup 40
- EDD (Enhanced Device Description) 54
- Electronics and terminal compartment, single chamber housing 20
- Error codes 58
- Event memory 55

**F**

- Factory calibration date 45
- False signal suppression 35

- Fault rectification 60
- Functional principle 8

**G**

- Gas phase 29
- Grounding 18

**H**

- HART address 44
- HART variables 35

**I**

- Inflowing medium 15
- Installation position 12

**K**

- Key function 23

**L**

- Language 37
- Linearization 31

**M**

- Main menu 26
- Meas. reliability 38
- Measured value indication 37
- Measured value memory 55
- Measurement loop name 27

**N**

- NAMUR NE 107 59
  - Failure 57

**P**

- Peak value indicator 38
- PIN 40
- Probe length 27
- Probe type 44

**Q**

- Quick setup 24

**R**

- Read out info 45
- Repair 63
- Replacement parts
  - Electronics module 11
  - Spacer 11
- Reset 41

**S**

- Scaling measured value 32, 33
- Sensor characteristics 45
- Sensor status 37
- Simulation 39
- Special parameters 44
- Status messages - NAMUR NE 107 56

**T**

- Type label 7
- Type of medium 28

**U**

- Units 27

MAN 1000244883 EN Version: - Status: RL (released | freigegeben) | printed: 22.09.2017

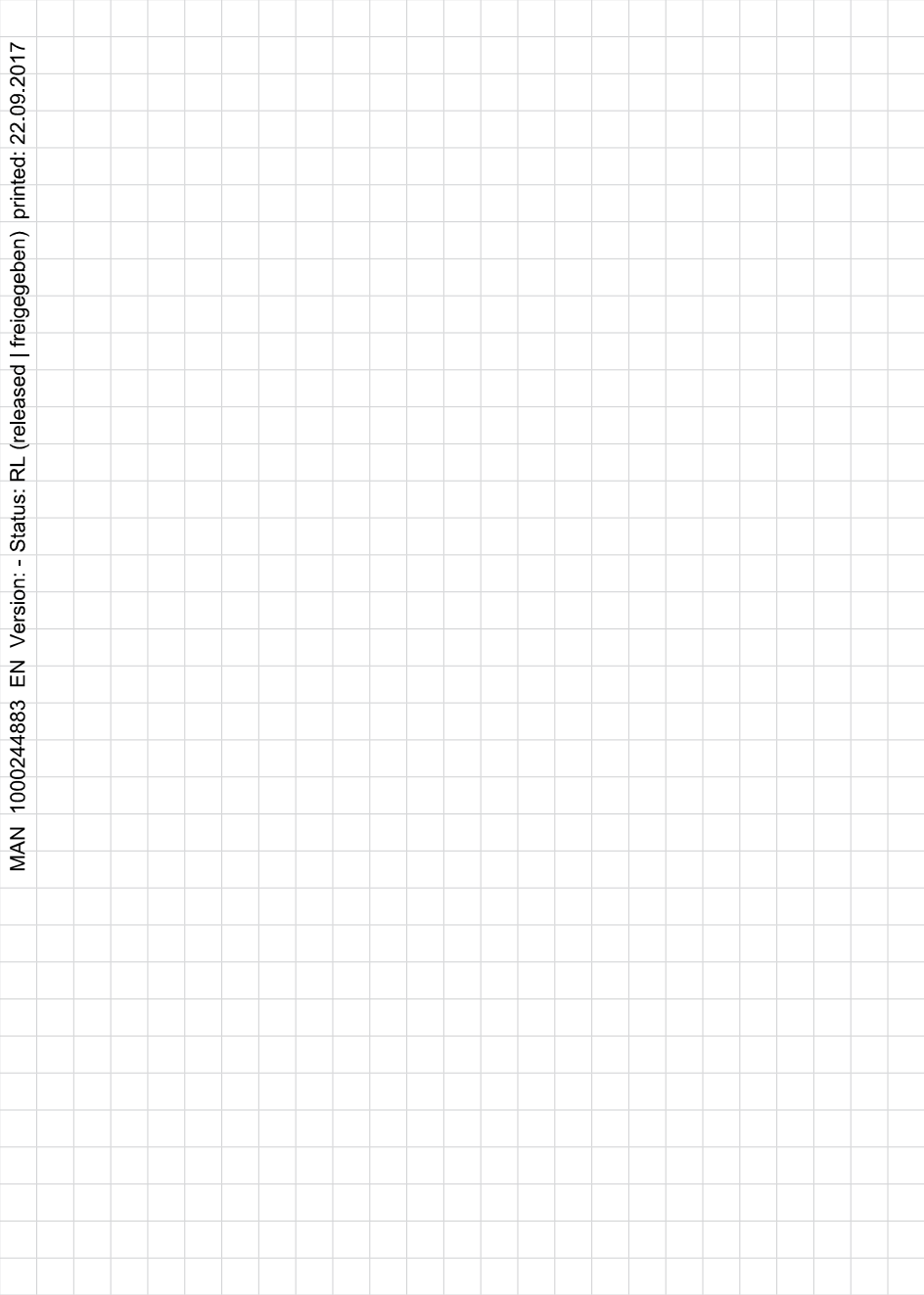

MAN 1000244883 EN Version: - Status: RL (released | freigegeben) printed: 22.09.2017

The smart choice  
of Fluid Control Systems  
[www.burkert.com](http://www.burkert.com)

**burkert**  
FLUID CONTROL SYSTEMS

46272-EN-140605