





## Electromotive 2-way globe proportional valve

- Actuator isolated from flow path
- Excellent range and fast response times
- Low power consumption
- Connection orifice DN 15...25
- Variants: standard, positioner, process controller

Product variants described in the data sheet may differ from the product presentation and description.

### Can be combined with

	<b>Type ME61</b> EDIP process display	▶
	<b>Type ME43</b> Fieldbus gateway	▶
	<b>Type 8098</b> FLOWave SAW flowmeter	▶
	<b>Type 8008</b> Flowmeter for gases	▶
	<b>Type 8325</b> Pressure transmitter for general applications, 0...25 bar	▶

### Type description

The direct-acting Type 3285 motor valve is suitable for dosing liquids and gases in closed or open control loops. The valve is driven by a stepper motor. The integrated electronics assembly simplifies the process integration; additional actuation modules are not necessary. The engine does not need any energy to maintain a certain valve opening. This feature can reduce the energy consumption of a plant dramatically and therefore make it more efficient. Type 3285 is available as an ON/OFF valve or proportional valve by default, as a variant with integrated positioner, and as a variant with integrated process controller.

## Table of contents

<b>1. General technical data</b>	<b>3</b>
1.1. General .....	3
1.2. Electrical control and interfaces.....	4
<b>2. Approvals and conformities</b>	<b>5</b>
2.1. General notes .....	5
2.2. Conformity .....	5
2.3. Standards.....	5
2.4. North America (USA/Canada) .....	5
2.5. Drinking water .....	5
2.6. Others .....	5
Oxygen .....	5
<b>3. Materials</b>	<b>6</b>
3.1. Bürkert resistApp .....	6
3.2. Material specifications .....	6
<b>4. Dimensions</b>	<b>7</b>
4.1. Threaded version.....	7
4.2. Capacitive buffer module .....	8
<b>5. Device/Process connections</b>	<b>9</b>
5.1. Analogue .....	9
5.2. Digital (fieldbus) .....	9
<b>6. Performance specifications</b>	<b>10</b>
6.1. Duty cycle derating diagram.....	10
6.2. Pressure range .....	10
6.3. Flow characteristic .....	11
Determination of the $K_v$ value.....	11
Exemplary characteristic curve of the motor valve .....	11
<b>7. Product operation</b>	<b>12</b>
<b>8. Product accessories</b>	<b>13</b>
8.1. Accessories capacitive buffer module.....	13
8.2. Bürkert Communicator Software.....	13
Connection Type 3285 with Bürkert Communicator software .....	14
<b>9. Ordering information</b>	<b>14</b>
9.1. Bürkert eShop .....	14
9.2. Recommendation regarding product selection.....	14
9.3. Bürkert product filter .....	14
9.4. Bürkert Product Enquiry Form .....	15
9.5. Ordering chart accessories.....	15
Standard accessories .....	15
Accessories cable.....	15
Bürkert accessories.....	15

## 1. General technical data

### 1.1. General

Product properties	
Dimensions	Further information can be found in chapter <a href="#">“4. Dimensions” on page 7.</a>
<b>Material</b>	
Further information can be found in chapter <a href="#">“3.2. Material specifications” on page 6.</a>	
Seal	<ul style="list-style-type: none"> <li>• NBR for liquids</li> <li>• EPDM for liquids and special gases (e. g. ammonia, acetylene)</li> <li>• FKM for neutral gases</li> </ul>
Seat sealing	Technical ceramics
Valve body	Brass or stainless steel
Nominal diameter	DN 15... DN 25, NPS ½...1
Flow direction	Above seat
Design	<ul style="list-style-type: none"> <li>• Disc On/Off valve</li> <li>• Disc control valve</li> </ul>
Weight	~ 0.8 kg (DN 8)...1.5 kg (DN 25)
Controller variant	Standard On/Off, standard control valve, position controller or process controller
Safety setting in case of power failure	With capacitive buffer module as accessory, see chapter <a href="#">“4.2. Capacitive buffer module” on page 8.</a>
Status display	LED (Refer to the <b>operating instructions Type 3285</b> ▶ for more information.)
Performance data	
<b>Typical values of positioning behaviour<sup>1)</sup></b>	
Dead band of the position control	± 0.5 % (corresponds to setting range 1:100)
Closing time	4 s
Operating pressure	0...6 bar(g) (see chapter <a href="#">“6.2. Pressure range” on page 10</a> ) Vacuum version (up to -0.9 bar(g)) (optional)
Duty cycle	Up to 100 % (depending on medium and ambient temperature)
K <sub>vs</sub> value	1.8...9.6 m <sup>3</sup> /h (see chapter <a href="#">“6.2. Pressure range” on page 10</a> )
Electrical data	
Operating voltage	24 V DC ± 10 % (max. residual ripple 10 %)
Power consumption	< 1 W in holding position Max. 12 W (depending on motor control)
Medium data	
Operating medium	Neutral gases, liquids
Medium temperature	<ul style="list-style-type: none"> <li>• EPDM (seal material): - 30 °C...+ 70 °C</li> <li>• FKM, NBR (seal material): 0 °C...+ 70 °C</li> </ul>
Viscosity	Max. 80 mm <sup>2</sup> /s (cSt)
Process/Port connection & communication	
Port connection	Threaded connection <ul style="list-style-type: none"> <li>• G (EN ISO 228 - 1)</li> <li>• NPT (ASME B 1.20.1)</li> </ul>
<b>Communication and control</b>	
Standard signal (analogue)	Setpoint: 0/4...20 mA, 0...5/10 V and digital input, see chapter <a href="#">“1.2. Electrical control and interfaces” on page 4.</a>
Fieldbus (digital)	<ul style="list-style-type: none"> <li>• Bürkert system bus (büS)</li> <li>• CANopen (optional)</li> </ul>
EDIP	Field device for integration into the EDIP platform via Bürkert system bus (büS) Further information can be found in chapter <a href="#">“8.2. Bürkert Communicator Software” on page 13.</a>
Approvals and conformities	
Degree of protection	IP50
North America (USA/Canada)	Further information can be found in chapter <a href="#">“2.4. North America (USA/Canada)” on page 5.</a>
Drinking water	Further information can be found in chapter <a href="#">“2.5. Drinking water” on page 5.</a>
Others	Further information can be found in chapter <a href="#">“2.6. Others” on page 5.</a>

Environment and installation	
Installation position	As required, preferably with actuator upright
Ambient temperature	- 10 °C...+ 60 °C (Derating see chapter "6.1. Duty cycle derating diagram" on page 10)

1.) The characteristic values of the control behaviour depend on the operating conditions and refer to the final value.

## 1.2. Electrical control and interfaces

Technical data	Device variant					
	Standard (G/H)		Positioner (C)		Process controller (D)	
	ON/OFF (G)	Control valve (H) <sup>1)</sup>	Analogue	Digital (fieldbus)	Analogue	Digital (fieldbus)
Electrical connection	M12 plug, A-coded, 8-pin	M12 plug, A-coded, 8-pin	M12 plug, A-coded, 8-pin	M12 plug, A-coded, 5-pin	M12 plug, A-coded, 8-pin and M12 socket, A-coded, 5-pin	M12 plug, A-coded, 5-pin and M12 socket, A-coded, 5-pin
Input signal (setpoint)	Digital input: 0...5 V (log. 0, valve closed) or 10...30 V (log. 1, valve open)	4...20 mA, 0...10 V or PWM (800 Hz) min: 10 V   type: 24 V   max: 30 V)	4...20 mA, 0...20 mA, 0...10 V or 0...5 V	–	4...20 mA, 0...20 mA, 0...10 V or 0...5 V	–
Input signal (actual value from ext. Sensor)	–	–	–	–	4...20 mA, 0...20 mA, 0...10 V or 0...5 V	4...20 mA, 0...20 mA, 0...10 V, 0...5 V or frequency (5...2000 Hz)
Input impedance for analogue input	22 kΩ	60 Ω (current), 22 kΩ (voltage)	60 Ω (current), 22 kΩ (voltage)	–	60 Ω (current), 22 kΩ (voltage)	60 Ω (current), 22 kΩ (voltage)
Output signal (actual value)	Digital output: PNP, max. 100 mA current limits, feedback function (output signal active, when valve closed)	Digital output: PNP, max. 100 mA current limits, feedback function (output signal active, when valve closed)	0/4...20 mA (max. load: 560 Ω), 0...5/10 V (max. current: 10 mA)	–	0/4...20 mA (max. load: 560 Ω), 0...5/10 V (max. current: 10 mA)	–
Fieldbus interface	–	–	–	büS/CANopen	–	büS/CANopen
Parameterization Tool	–	–	Bürkert Communicator (Connection via büS stick)	Bürkert Communicator (Connection via büS stick)	Bürkert Communicator (Connection via büS stick)	Bürkert Communicator (Connection via büS stick)

1.) The standard control valve variant is a proportional valve which, like the positioner variant, changes the valve stroke continuously depending on the input signal. This variant has no büS interface and no analogue output signal.

DTS 1000256911 EN Version: Z Status: RL (released | freigegeben | validé) printed: 15.01.2025

## 2. Approvals and conformities

### 2.1. General notes

- The approvals and conformities listed below must be stated when making enquiries. This is the only way to ensure that the product complies with all required specifications.
- Not all available versions can be supplied with the below mentioned approvals or conformities.

### 2.2. Conformity

In accordance with the Declaration of conformity, the product is compliant with the EU Directives.

### 2.3. Standards

The applied standards which are used to demonstrate compliance with the EU Directives are listed in the EU-Type Examination Certificate and/or the EU Declaration of Conformity.

### 2.4. North America (USA/Canada)

Approval	Description
	<b>Optional: UL Recognized for the USA and Canada<sup>1)</sup></b> The products are UL Recognized for the USA and Canada according to: <ul style="list-style-type: none"> <li>• UL 429 (electrically operated valves)</li> <li>• CAN/CSA-C22.2 No. 139 (electrically operated valves)</li> </ul>

1.) This device is intended to be used with a NEC Class 2 power source or NEC Class 2 transformer in accordance with UL1310 or UL1585.

### 2.5. Drinking water

Conformity	Description
	<b>Suitable for use in drinking water applications</b> The materials comply with the assessment principles (UBA) for materials in contact with drinking water (Trinkwasser).  <b>Brass body/Stainless steel body:</b> PF39: Suitable for products with a maximum temperature of 85 °C (hot water)

### 2.6. Others

#### Oxygen

Conformity	Description
	<b>Oxygen</b> In their composition, the products are suitable for use with gaseous oxygen (optional).

### 3. Materials

#### 3.1. Bürkert resistApp



**Bürkert resistApp – Chemical resistance chart**

You want to ensure the reliability and durability of the materials in your individual application case? Verify your combination of media and materials on our website or in our resistApp.

[Start chemical resistance check](#)

#### 3.2. Material specifications

**Note:**

The globe control valve Type 3285 is supplied with various port connections. These connections are not shown completely. However, they correspond to the material of the valve housing.

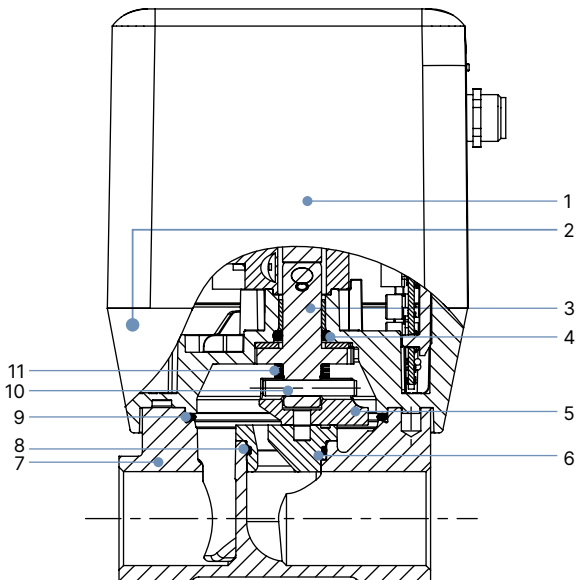

**Actuator**

No.	Element	Material
1	Housing cover	PC (Polycarbonate)
2	Housing base	PPS (Polyphenylene sulfide)

**Valve body**

No.	Element	Material
3	Spindle	Stainless steel 1.4404/1.4401
4	Spindle seal	FKM/EPDM/NBR
5	Disc	Technical ceramics
6	Valve seat	Technical ceramics
7	Valve body	Brass or stainless steel 1.4408
8	O-ring	FKM/EPDM/NBR
9	O-ring	FKM/EPDM/NBR
10	Parallel pin	Stainless steel 1.4401
11	Spring	Spring steel/Stainless steel

DTS 1000256911 EN Version: Z Status: RL (released | freigegeben | validé) printed: 15.01.2025

## 4. Dimensions

### 4.1. Threaded version

**Note:**

Dimensions in mm

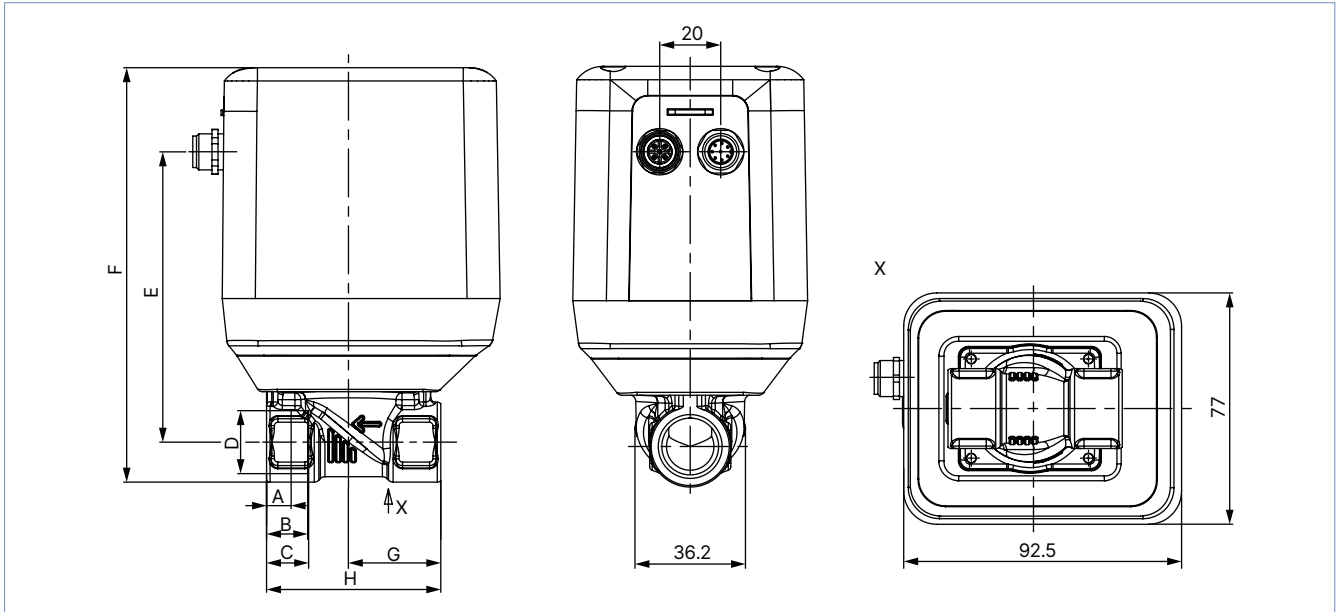

A	B	C	D	E	F	G	H	H
8.2	13.7	-	NPT 1/2	97	138	31	58	26.6
-	-	14	G 1/2	97	138	31	58	26.6
8.6	14	-	NPT 3/4	103.5	147	43	80	32
-	-	16	G 3/4	103.5	147	43	80	32
10.2	16.8	-	NPT 1	108.5	156.5	49	95	41
-	-	18	G 1	108.5	156.5	49	95	41

## 4.2. Capacitive buffer module

**Note:**

- Dimensions in mm
- Further information can be found in chapter "8.1. Accessories capacitive buffer module" on page 13.

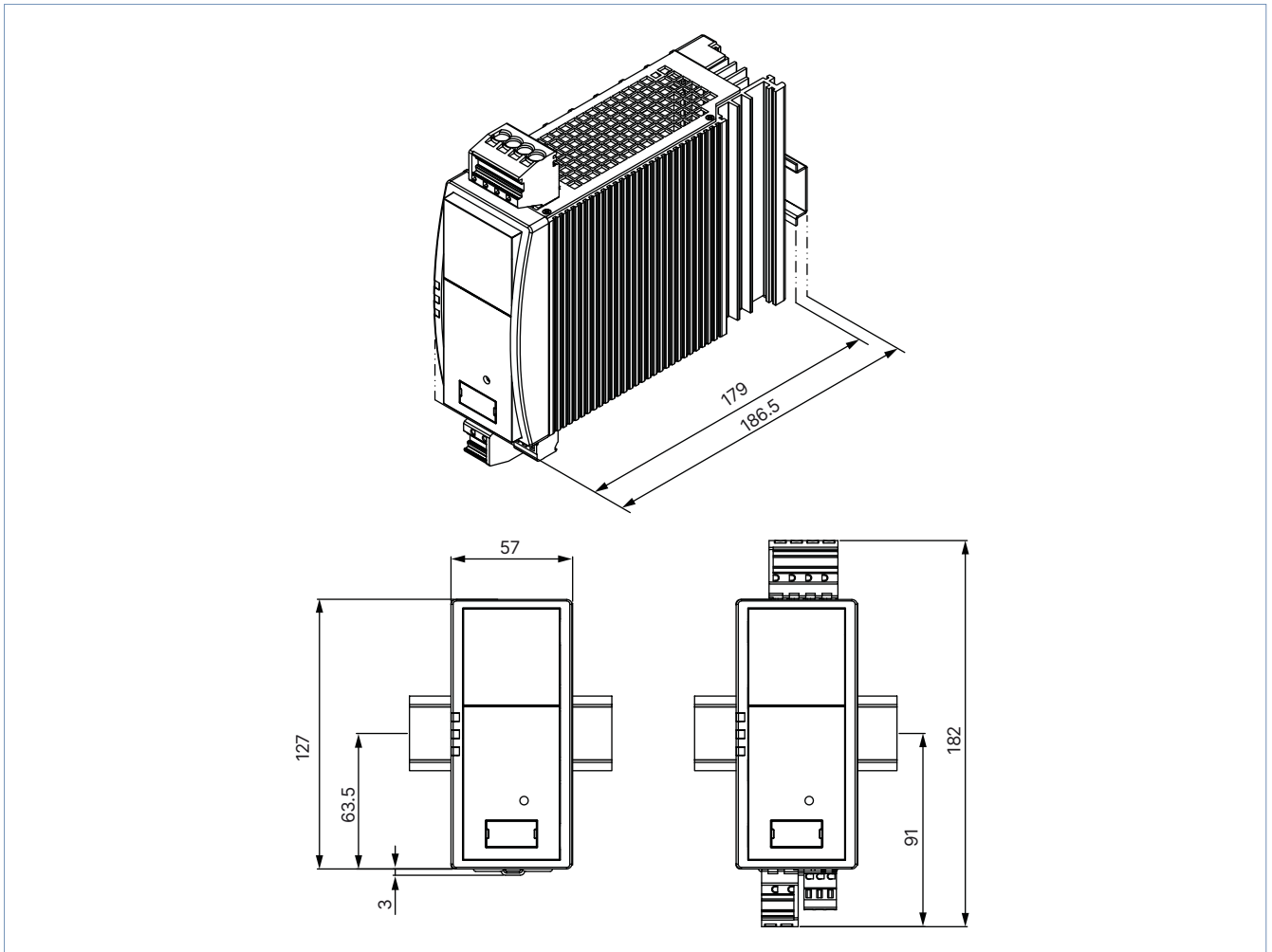



## 5. Device/Process connections

### 5.1. Analogue

**Note:**

For parameterisation and configuration of the positioner and the process controller variants, please use the Bürkert Communicator software tool, see ["8.2. Bürkert Communicator Software" on page 13](#).

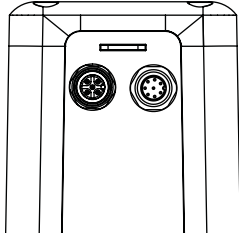

Circular connector M12, 8-pin	Pin	Configuration
	1	24 V DC
	2	Power supply GND
	3	Internal use <sup>1)</sup>
	4	Internal use <sup>1)</sup>
	5	Internal use <sup>1)</sup>
	6	Signal input +
	7	Signal output
	8	Signal GND

1.) Only for positioners and process controllers variant, for connection of the parameterization tools: Bürkert Communicator. The connection is via the bus-Stick. Using an adapter cable (M12 8-pin to M12 5-pin) the bus-Stick can be connected, see ["9.5. Ordering chart accessories" on page 15](#).

Additional for process controller variant:

Socket M12, 5-pin	Pin	Configuration
	1	24 V DC sensor power supply
	2	Analogue $I_N$ (0...20 mA, 4...20 mA, 0...5 V or 0...10 V)
	3	GND
	4	GND (bridge according to GND pin 3)
	5	Not connected

### 5.2. Digital (fieldbus)

**Note:**

For parameterisation and configuration of the positioner and the process controller variants, please use the Bürkert Communicator software tool, see ["8.2. Bürkert Communicator Software" on page 13](#).

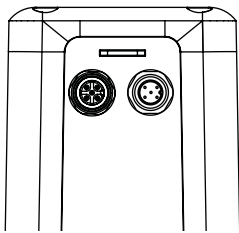

Circular connector M12, 5-pin	Pin	Configuration
	1	Shield
	2	24 V DC
	3	GND
	4	CAN high
	5	CAN low

Additional for process controller variant:

Socket M12, 5-pin	Pin	Configuration
	1	24 V DC sensor power supply
	2	Analogue $I_N$ (0...20 mA, 4...20 mA, 0...5 V, 0...10 V or frequency)
	3	GND
	4	GND (bridge according to GND pin 3)
	5	Not connected

## 6. Performance specifications

### 6.1. Duty cycle derating diagram

**Note:**

- The duty cycle is an important factor for motor valves. The self-heating of the engine limits the maximum duty cycle. High ambient temperatures additionally increase the risk of damage due to overheating. The following diagram shows the recommended maximum duty cycle as a function of the ambient temperature. In energy-saving mode (lower driving force), higher duty cycles are possible. The motor is optimised for the valve function in terms of size, power consumption and costs.
- The duty cycle does not mean the duty cycle of the device but the duty cycle of the motor. This is only switched on when the valve is to move. Frequent set-point value changes drastically increase the duty cycle of the motor.
- Operating the valve outside the recommended duty cycle limits will result in a significantly reduced service life of the valve.

Derating curve for standard version

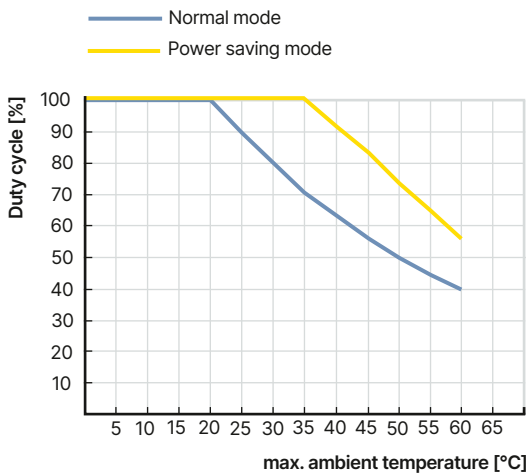

Derating curve for positioner and process controller

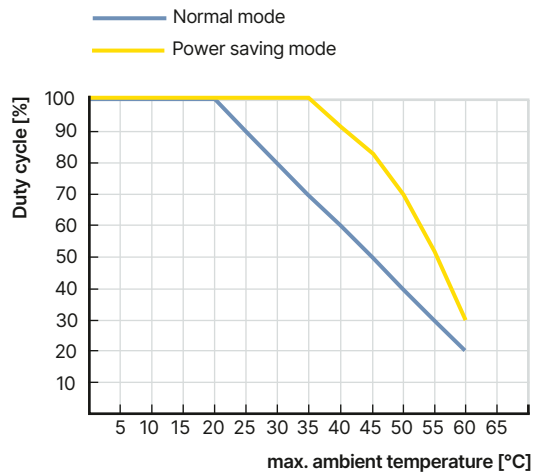

### 6.2. Pressure range

**Note:**

For orders from our standard product range, use the product filter in our eShop (see "9.1. Bürkert eShop" on page 14). Alternatively, you can use the Product Enquiry Form (see "9.4. Bürkert Product Enquiry Form" on page 15) for information about the device layout and send it to us after completion.

Valve function	Seat size	Port connection <sup>1)</sup>	K <sub>vs</sub> -value water [m <sup>3</sup> /h] <sup>2)</sup>	Pressure range <sup>3)</sup> [bar(g)]
Control valve, without safety position in case of power failure	8	G 1/2	1.8	6
	10	G 1/2	2.5	6
	12	G 3/4	3.9	6
	15	G 3/4	5.4	6
	20	G 1	8.1	6
	25	G 1	9.6	6

1.) Other port connections (NPT, ...) on request  
 2.) Measurement at +20 °C, 1 bar pressure difference above the fully open valve  
 3.) Fuel gases may vary

Further versions on request	
<p><b>Temperature</b>                      Low temperature variant:                      Suitable for minimum medium temperatures down to -30 °C (sealing material EPDM) (optional)</p>	<p><b>Pressure</b>                      Vacuum variant:                      This variant is suitable up to -0.9 bar(g) (optional)</p>

### 6.3. Flow characteristic

#### Determination of the $K_v$ value

**Note:**

Once the  $K_v$ -value required for the application has been calculated, it can be compared with the  $K_{vs}$ -values from the ordering chart. The  $K_{vs}$ -value must be higher than the  $K_v$ -value of the application, but should be neither too high nor too close to it - as a recommendation: 10 % higher.

Pressure drop	$K_v$ value for liquids [m <sup>3</sup> /h]	$K_v$ value for gases [m <sup>3</sup> /h]	Value	Description	Unit
<b>Sub-critical</b> $p_2 > \frac{p_1}{2}$	$= Q \sqrt{\frac{\rho}{1000 \Delta p}}$	$= \frac{Q_N}{514} \sqrt{\frac{T_1 \rho_N}{p_2 \Delta p}}$	$K_v$	Flow coefficient	[m <sup>3</sup> /h] <sup>1.)</sup>
<b>Supercritical</b> $p_2 < \frac{p_1}{2}$	$= Q \sqrt{\frac{\rho}{1000 \Delta p}}$	$= \frac{Q_N}{257 p_1} \sqrt{T_1 \rho_N}$	$Q_N$	Standard flow rate	[m <sup>3</sup> /h] <sup>2.)</sup>
			$p_1$	Inlet pressure	[bar] <sup>3.)</sup>
			$p_2$	Outlet pressure	[bar] <sup>3.)</sup>
			$\Delta p$	Differential pressure $p_1 \dots p_2$	[bar]
			$\rho$	Density	[kg/m <sup>3</sup> ]
			$\rho_N$	Standard density	[kg/m <sup>3</sup> ]
			$T_1$	Medium temperature	[(273+t)K]

- 1.) Measured for water,  $\Delta p = 1$  bar, over the value
- 2.) At reference conditions 1.013 bar and 0 °C (273 K)
- 3.) Absolute pressure

#### Exemplary characteristic curve of the motor valve

**Note:**

The design of the seat size is very important for the proper functioning of electromotive proportional valves within the application. The seat size must be selected in such a way that, on the one hand, the desired flow range is achieved and, on the other hand, when the valve is fully open, a sufficient part of the total pressure drop takes place via the valve.

Reference value:  $\Delta p$  valve > 25 % of the total pressure drop

Otherwise, an ideal, linear valve characteristic is deformed into a curved system characteristic.

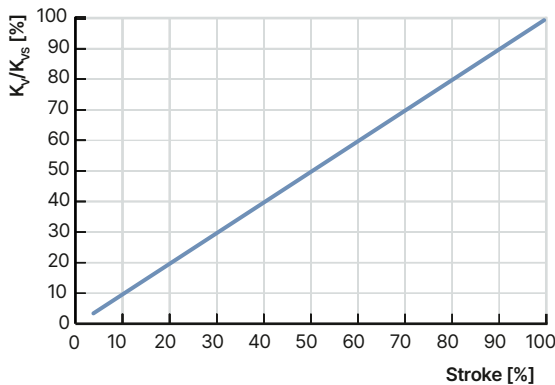

Linear flow characteristic - the  $K_{vs}$  values of the respective seat sizes can be found in chapter "6.2. Pressure range" on page 10.

DTS 1000256911 EN Version: Z Status: RL (released | freigegeben | valide) printed: 15.01.2025

## 7. Product operation

### Standard on/off valve

In the ON/OFF variant, an external voltage signal is digitized and the valve is closed or opened. The status of the two end positions of the valve are indicated on the LED. In addition, the valve position "closed" is reached via the digital output.

### Standard control valve

The standard proportional valve converts an external standard signal (position set-point value) into a valve position. Both valve end positions are indicated by the LED status. Additionally, the digital output indicates when the "closed" valve position has been achieved.

Process diagram	Description
	<p><b>Positioner variant</b></p> <p>The proportional valve in the position control variant converts an external standard signal, the position set-point value, into a valve position. The position of the actuator is controlled according to the set-point position. The position sensor records the current position (POS) of the electromotive valve. This actual position is compared by the positioner with the set-point value (CMD) specified as the standard signal. If there is a control difference (Xd1), a motor control signal is given to the actuator as the actuating variable. Z1 is a disturbance value.</p> <p>The two end positions of the valve are indicated by the LED status. In addition, the actual position recorded by the position sensor is output via the M12 circular plug-in connector.</p>
	<p><b>Process controller variant</b></p> <p>The additionally implemented PID controller can perform not only the actual position control but also a process control in the sense of a cascade control.</p> <p>The process controller is integrated into a control loop. The position setpoint of the valve is calculated from the process setpoint and the actual process value via the control parameters (PID controller). The process setpoint can be specified by an external signal.</p> <p>During the process control the position control mentioned above becomes the subordinate auxiliary control circuit; this results in a cascade control. The process controller in the main control circuit has a PID function.</p> <p>The process set-point value (SP) is specified as a set-point value and is compared with the actual value (PV) of the process variable to be controlled. The position measuring system records the current position (POS) of the electromotive linear actuator. This position actual value is compared by the position controller with the set-point value (CMD) specified by the process controller. If there is a control difference (Xd2), the actual position (POS) and therefore the valve opening are changed by the control variable (CTRL). Z2 represents a disturbance variable.</p>

DTS 1000256911 EN Version: Z Status: RL (released | freigegeben | valide) printed: 15.01.2025

## 8. Product accessories

### 8.1. Accessories capacitive buffer module

**Note:**

- See [“4.2. Capacitive buffer module” on page 8](#) for information about dimensions.
- See [“Standard accessories” on page 15](#) for ordering information.

Accessories	Description
<p>Motor valve(s) connection</p>  <p>24 V DC power supply For example: Single phase, primary switched mode power supply Type 1573</p>	<ul style="list-style-type: none"> <li>• Capacitive buffer module for moving to a safety position in case of power failure</li> <li>• In order to be able to move to a safety position of the valve in the event of a power failure, the valve must be supplied with voltage via the capacitive buffer module. In the event of a power failure, the buffer module provides an output voltage of 18 V DC for a few seconds. The reduced input voltage is detected by the valve and the safety position is approached accordingly. Up to 3 valves of Type 3280 or 2 valves of Type 3281 and Type 3285 can be connected to a buffer module. Factory setting of the safety position: “valve closed”</li> <li>• For standard version (functionality available from software version A.08): Adjustable via DIP switch (when the operating direction is reversed, the safety position changes to “valve open”)</li> <li>• For positioner and process controller variant (functionality available from software version A.06): Adjustable via Bürkert Communicator (user-defined safety position)</li> </ul>

### 8.2. Bürkert Communicator Software

**Note:**

- An adjustment of the valve by the Bürkert Communicator is only possible with the positioner or process controller variants.
- The associated communication software can be downloaded under [Type 8920](#) ▶.

The Bürkert Communicator is the most important software tool of the device platform EDIP (Efficient Device Integration Platform). The extensive features of this universal tool facilitate the configuration and parameterisation of all devices equipped with the digital CANOpen-based interface.

The Bürkert Communicator provides the user with a complete overview of all cyclic process values and acyclic diagnostic data. The integrated graphical programming environment enables the creation of control functions for decentralised sub-systems. The connection to the PC can be established via a USB-büS interface set. This is available as an accessory (see [“9.5. Ordering chart accessories” on page 15](#)).

The Bürkert Communicator enables:

- Configuration, parameterisation and diagnosis of EDIP devices / networks
- Easy and convenient assignment (mapping) of cyclical values
- Graphical display of process values
- Firmware update of the connected EDIP devices
- Saving and restoring device configurations

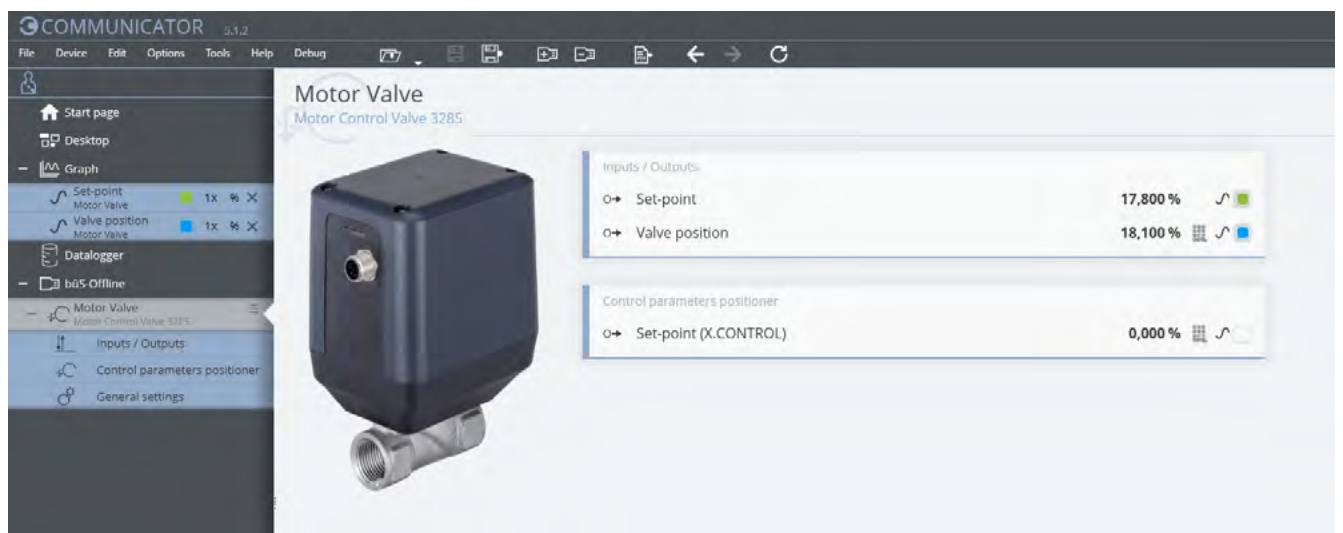

DTS 1000256911 EN Version: Z Status: RL (released | freigegeben | validé) printed: 15.01.2025

**Connection Type 3285 with Bürkert Communicator software**

The interface to the “Bürkert Communicator” software tool is based on CANopen. A corresponding bus termination is mandatory. For variants with standard signal interfaces, please activate the switchable terminating resistor on the bÜS stick. For variants with bÜS/CANopen communication interface, this terminating resistor should not be switched on if the device is already integrated in a properly terminated bus network.

- A bÜS stick is required to connect the motor valve to the “Bürkert Communicator” software tool. The bÜS stick sets contain the necessary accessories.
- For variants with bÜS/CANopen communication interface, the connection is made directly via the 5-pin M12 plug (bÜS stick set 1 contains the necessary accessories).
- Variants with standard signal interfaces are connected via the 8-pin M12 plug on the device (bÜS stick set 1 + bÜS adapter; socket 8-pin M12 to plug 5-pin M12 contain the necessary accessories).

**9. Ordering information**

**9.1. Bürkert eShop**



**Bürkert eShop – Easy ordering and quick delivery**

You want to find your desired Bürkert product or spare part quickly and order directly? Our online shop is available for you 24/7. Sign up and enjoy all the benefits.

[Order online now](#)

**9.2. Recommendation regarding product selection**

**Note:**

- The configuration of the seat size is very important for proportional valves to ensure proper functioning within the application. The seat size must be selected in such a way that on the one hand the desired flow range is achieved and on the other hand a sufficient part of the total pressure drop across the valve takes place when the valve is fully open.
- Reference value: pressure drop of the valve > 25 % of the total pressure drop
- Let Bürkert engineers advise you already in the planning phase.

**9.3. Bürkert product filter**



**Bürkert product filter – Get quickly to the right product**

You want to select products comfortably based on your technical requirements? Use the Bürkert product filter and find suitable articles for your application quickly and easily.

[Try out our product filter](#)

DTS 1000256911 EN Version: Z Status: RL (released | freigegeben | validé) printed: 15.01.2025

## 9.4. Bürkert Product Enquiry Form

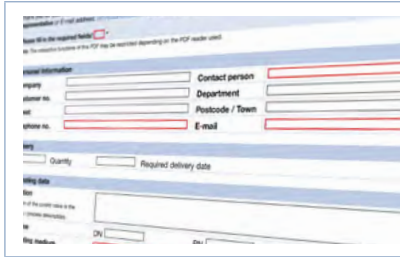





### Bürkert Product Enquiry Form – Your enquiry quickly and compactly

Would you like to make a specific product enquiry based on your technical requirements? Use our Product Enquiry Form for this purpose. There you will find all the relevant information for your Bürkert contact. This will enable us to provide you with the best possible advice.



[Fill out the form now](#)

## 9.5. Ordering chart accessories

### Standard accessories

Description	Article no.
Power supply unit Phoenix Class2 (Type 1573), 85...240 V AC/24 V DC, 1.25 A, NEC Class 2 (UL 1310)	772438 
Power supply unit for standard rail (Type 1573), 100...240 V AC/24 V DC, 1 A, NEC Class 2 (UL 1310)	772361 
Power supply unit for standard rail (Type 1573), 100...240 V AC/24 V DC, 2 A, NEC Class 2 (UL 1310)	772362 
Power supply unit for standard rail (Type 1573), 100...240 V AC/24 V DC, 4 A	772363 
Buffer module (Type 1573) for safety position when power failure	773440 



### Accessories cable

Description	Article no.
M12 circular socket with cable, 8-pin, cable length: 2 m, ready-made cable for input and output signals (for analogue variant)	919061 
M12 circular female connector with cable, 8-pin, cable length: 2 m, ready-made shielded cable for input and output signals (for analogue variant)	918991 
M12 cable shielded, 5-pin, cable length: 2 m, ready-made shielded cable for actual process value input signals (only for variant with analogue/digital process controller)	559177 

### Bürkert accessories

#### Note:

- For connection to a bÜS/CANopen network, see **cabling guide** ►. Detailed accessory tables can be found in the wiring guide
- Can only be used with positioner and process controller variant.

Description	Article no.
Software Bürkert Communicator	<b>Type 8920</b> ►
bÜS adapter, M12 socket, 8-pin to M12 plug, 5-pin (for bÜS stick connection)	773286 
USB bÜS interface set 1 (Type 8923) for connection to the Bürkert Communicator software: including connection cable (M12 and micro USB), stick with integrated terminating resistor, power supply and software	772426 
USB bÜS interface set 2 (Type 8923) for connection to the Bürkert Communicator software: including bÜS stick, connection cable to M12 plug, M12 connection cable on micro USB for the bÜS service interface and Y distributor, cable length: 0.7 m	772551 